

NES NORDIC ELECTRIC POWER CO- OPERATION	TECHNICAL SPECIFICATION FROM THE NES GROUP	TS 02 PAGES: 67 ENCLOSURES: 9 DATE: 05.01.2007
---	---	--

**Requirements on rolling stock
in Norway and Sweden
regarding EMC with the
electrical infrastructure and
coordination with the power
supply and other vehicles**

TABLE OF CONTENTS

1	SCOPE	4
2	REFERENCES	7
2.1	NORMATIVE REFERENCES	7
2.2	OTHER REFERENCES	8
3	DEFINITIONS	9
4	GENERAL INFORMATION OF RELATED INFRASTRUCTURE	10
4.1	GENERAL	10
4.2	NORWAY	10
4.3	SWEDEN	11
5	SPECIFIC REQUIREMENTS REGARDING SAFETY, SAFETY SYSTEMS AND THIRD PARTY	12
5.1	SAFETY WITH RESPECT TO ELECTRICITY	12
5.2	TRACK SIGNALLING CIRCUITS	13
5.3	RADIATED INTERFERENCE	22
5.4	TELECOMMUNICATION DISTURBANCES AND PSOPHOMETRIC CURRENTS	22
6	REQUIREMENTS REGARDING COMPATIBILITY WITH THE POWER SUPPLY AND OTHER ISSUES	25
6.1	LINE VOLTAGE	25
6.1.1	<i>Levels</i>	25
6.1.2	<i>Frequency</i>	26
6.1.3	<i>Harmonics</i>	27
6.2	NEUTRAL SECTIONS	29
6.3	POWER FACTOR	30
6.4	CURRENT LIMITATION	34
6.4.1	<i>Maximum current limitation</i>	34
6.4.2	<i>Current or power control at low voltage</i>	35
6.5	HARMONICS AND DYNAMIC EFFECTS.....	36
6.5.1	<i>Low frequency power oscillations</i>	36
6.5.2	<i>Electrical resonance stability</i>	40
6.5.3	<i>Current harmonics</i>	42
6.6	RELAY PROTECTION AND COORDINATION.....	43
6.7	AC INRUSH CURRENTS.....	45
6.8	REGENERATIVE BRAKING	46
6.9	OTHER SPECIAL REQUIREMENTS	48
6.9.1	<i>Train pre-heating systems</i>	48
6.9.2	<i>Energy measurements</i>	49
6.9.3	<i>Outside antennas on vehicles</i>	50
6.9.4	<i>Other electrical equipment</i>	51
7	VALIDATION AND TESTS	52
7.1	PRE-REQUIREMENTS	52
7.1.1	<i>Current components which can effect signalling circuits and telecommunications</i>	52
7.1.2	<i>Radiated EMC</i>	52
7.1.3	<i>Simulations of dynamic vehicle behaviour</i>	52
7.1.4	<i>Current or power control at low voltage</i>	53
7.1.5	<i>Regenerative braking</i>	53
7.1.6	<i>Test plan</i>	53

7.2	TESTS REGARDING SAFETY, SAFETY SYSTEMS AND THIRD PARTY	53
7.3	TESTS REGARDING COMPATIBILITY WITH THE POWER SUPPLY	53
7.3.1	<i>Voltage levels verification tests</i>	56
7.3.2	<i>Harmonics withstand verification tests</i>	56
7.3.3	<i>Power factor verification tests</i>	56
7.3.4	<i>Maximum current limitation verification tests</i>	57
7.3.5	<i>Current or power control at low voltage verification tests</i>	57
7.3.6	<i>Harmonics and dynamic effects validation tests</i>	57
7.3.7	<i>AC inrush current verification tests</i>	59
7.3.8	<i>Regenerative braking verification tests</i>	59
7.3.9	<i>Train heating systems verification tests</i>	60
7.4	MEASUREMENT INSTRUMENTATION AND METHODS	60
7.4.1	<i>Measurements - radiated entities</i>	60
7.4.2	<i>Measurement instrumentation – conducted entities</i>	60
7.4.3	<i>Measurement methods/analysis – conducted entities</i>	61
8	DOCUMENTATION	64
8.1	GENERAL	64
8.2	INPUT DATA FOR SIMULATIONS	64
9	REVISION HISTORY	67

APPENDICES 51 PAGES

APP. 1:	INFRASTRUCTURE DATA AND RELATED INFORMATION	27 PAGES
APP. 2:	NETWORK MAP OF NORWAY	1 PAGE
APP. 3:	NETWORK MAP OF SWEDEN	2 PAGES
APP. 4:	ADDITIONAL INFORMATION FOR STABILITY STUDIES	4 PAGES
APP. 5:	DYNAMIC BEHAVIOUR FOR ROTARY CONVERTERS	19 PAGES
APP. 6:	TYPICAL CROSS SECTION OF A BOOSTER TRANSFORMER LINE IN SWEDEN	1 PAGE
APP. 7:	CROSS SECTION OF EXISTING AT-SYSTEM LINES IN SWEDEN	1 PAGE
APP. 8:	CROSS SECTION OF NEW STANDARD FOR AT-SYSTEM LINES IN SWEDEN	1 PAGE
APP. 9:	PSOPHOMETRIC WEIGHTING FACTORS ACCORDING TO ITU-T	2 PAGES

1 SCOPE

Existing and new standards regarding different aspects of compatibility between vehicles and electrical infrastructure do not cover all issues, especially those issues which are special for Norway and Sweden. This has been experienced in different acceptance processes of new vehicles.

The objective of this document is to compile all relevant electrical requirements on rolling stock, foremost electrical locomotives and EMU's, to be used in Norway and Sweden, with respect to compatibility with the electrical infrastructure and other vehicles, i.e. the existing power supply, existing rolling stock and adjacent systems such as track signalling circuits, telecommunication lines and others.

The requirements on the interaction between the pantograph and the contact line are however presented in a separate document. Furthermore, the requirements on train control systems, such as ATC (= Automatic Train Control) or ERTMS, and interference with train radio and digital systems such as PCM, ISDN, etc., are excluded in this document.

The document is foremost intended to be used by manufacturers or operators who intend to put vehicles in to operation in Norway and Sweden. The document is however also intended to be an aid for a manufacturer who is about to design a vehicle for operation in these countries and to point out the difficulties that can arise from the conditions that are valid in these countries, special conditions such as high earth resistivity, weak networks in combination with frequency converters for feeding the power supply network, synchronism to the 50 Hz network (decentralized power supply), and so on. The last two conditions are valid for Norway and Sweden only. For this purpose the document contains quite a lot of information about the infrastructure in these countries. Some information can be found in connection with different requirements but most of the information is given in the attached appendices.

The document is first and foremost based on the standards EN 50 121 part 1 to 5, EN 50 163, EN 50 238 and EN 50 388. This does not imply that other standards are obsolete.

The document concentrates on the special national conditions that are valid for Norway or Sweden and topics that are not completely covered by the standards mentioned above.

The requirements in this document are valid for:

- First time use of rolling stock or reintroduction of rolling stock that have been considered out of use permanently.
- Rolling stock that is going to be introduced on sections of track not included in current acceptance.
- Changes, both in hardware and software, in rolling stock usage not in compliance with current acceptance.
- Modifications of rolling stock in a way that may affect the compliance with the current acceptance.

This means that the requirements in this document are valid for new electrical traction vehicle and old used vehicles that have not been used in normal operation in Norway or Sweden before. An old vehicle used in one of the countries Norway or Sweden is, however, not automatically accepted in the other country.

The requirements in this document can however be discussed when applied on imported old vehicles, except for the Electrical Safety and requirements regarding signalling circuits and psophometric currents. Requirements regarding signalling circuits are always valid due to safety aspects. Requirements regarding psophometric currents are valid due to effects for third party.

The intension is to harmonize the requirements and tests as much as possible. The aim is that if a vehicle is found to be compatible with a certain common requirement in one of the countries, then this is also valid in the other country.

The tests described are meant to be type tests. This means that if tests are performed in one country, and the test procedure is the same in the other country, then the test results are also valid in the other country, even if the limits are different (i.e. tests in one country can provide data also for the other country).

It should be noted however that due to some differences in the power supply systems and adjacent systems in Norway and Sweden, the objective above cannot be fulfilled for all requirements.

A summary of how and for which rolling stock the requirements are valid is given in the table below:

Rolling stock	New	Existing
Domestic (only for use in either Norway or Sweden)	All requirements are mandatory.	<p>Already accepted, but any rebuilds or modifications should aim for improving compatibility.</p> <p>For already accepted vehicles, which are to be put in operation on new lines for which the acceptance is not valid, relevant requirements are valid in order to maintain traffic and not to disturb the electrical infrastructure. Relevant requirements are decided on a case-to-case basis.</p>
Foreign (vehicles for cross border operation or vehicles for use in several other countries)	Safety related requirements and requirements regarding third party are mandatory. Non-compatibilities with other requirements might be accepted on a case-to-case basis if it can be demonstrated that the requirements are in fundamental conflict with requirements from other countries of operation.	Safety related requirements and requirements regarding psophometric current are mandatory. Non-compatibilities with other requirements might be accepted on a case-to-case basis if it can be demonstrated that the cost of a rebuild is out of proportion, or in fundamental conflict with requirements from other countries of operation.

2 REFERENCES

2.1 Normative references

- [1] EN 50 110-1: Operation of electrical installations. CENELEC, European Standard.
- [2] EN 50 121: Railway applications – Electromagnetic compatibility (relevant parts in this context).
Part 1: General
Part 2: Emission of the whole system to the outside world
Part 3-1: Rolling stock – Train and complete vehicle
Part 3-2: Rolling stock – Apparatus
Part 4: Emission and immunity of the signalling and telecommunication apparatus
Part 5: Emission and immunity of fixed power supply installations and apparatus
CENELEC, European Standard.
- [3] EN 50 122-1 Railway applications- Fixed installations Part 1: Protective provisions relating to electrical safety and earthing. CENELEC, European Standard.
- [4] EN 50 128: Railway applications – Communications, signalling and processing systems – Software for control and protection systems. CENELEC, European Standard.
- [5] EN 50 153: Railway applications – Protective provisions relating to electrical hazards. CENELEC, European Standard.
- [6] EN 50 155: Railway applications Electronic equipment used on rolling stock. CENELEC, European Standard.
- [7] EN 50 163: Railway applications – Supply voltages of traction systems. CENELEC, European Standard.
- [8] EN 50 207: Railway applications – Electronic power converters for rolling stock. CENELEC, European Standard.
- [9] EN 50 215: Railway applications – Test of rolling stock after completion of construction and before entry into service. CENELEC, European Standard.
- [10] EN 50 238: Railway applications – Compatibility between rolling stock and train detection systems. CENELEC, European Standard.
- [11] EN 50 388: Railway applications – Power supply and rolling stock – Technical criteria for the coordination between power supply (substation) and rolling stock to achieve interoperability. CENELEC, European Standard.
- [12] UIC 550, 550-1, 550-2, 550-3: Power supply installations for passenger stock.
- [13] UIC 552: Electrical power supply for trains – Standard technical characteristics of the train line.
- [14] UIC 554-1: Power supply to electrical equipment on stationary vehicles from local mains system or another source of energy at 220 V or 380 V, 50 Hz.

- [15] BVF 544.14002: Requirements on safe short circuit of track signalling circuits (only published in Swedish: "Säker kortslutning av spårledning"). Swedish National Rail Administration. Only normative for Sweden.
- [16] BVS 545.43501: Requirements on external antennas for railway vehicles (only published in Swedish: "Krav på yttre antenner för järnvägsfordon") . Swedish National Rail Administration. Only normative for Sweden.

2.2 Other references

- [17] HS TSI: Directive 96/48/EC – Interoperability of the trans-European high speed rail system, 96/48 ST14EN03 ENE part 2, Draft from 22.06.2006.
- [18] Characteristics of infrastructure. Document JD 590. Norwegian National Rail Administration, 01.02.2005.
- [19] Electro-technical requirements on new electrical vehicles regarding compatibility with the power supply system and other electrical vehicles, BKE 00/14, rev. H. Swedish National Rail Administration, July 2004. Not published.
- [20] Rc4 Inrush Test Results. Lars Buhrkall, 8.12.2006.
- [21] Monitoring of DC Interference currents. Lars Buhrkall, 27.05.2006.
- [22] Measurements in connection with approval of vehicles, Lars Buhrkall, October 2005. Not published.
- [23] Best practice to reach compatibility between rail vehicles and power supply. emkamatik document 06-0105, ver. 1. Markus Meyer, emkamatik, 3.2.2006.
- [24] Compatibility between power supply and trains. emkamatik document 05-0085, ver. 2. Markus Meyer, emkamatik, 17.1.2006. Not published.
- [25] AT system model structure and frequency responses. emkamatik document 05-0088, ver. 1. Stefan Menth, emkamatik, 31.10.2006.
- [26] AT system stability analysis. emkamatik document 05-0089, ver. 3. Markus Meyer, emkamatik, 19.1.2006.
- [27] Rotating converters BV/JBV: Description of simulation model. emkamatik document 06-0132, ver. 1. Stefan Menth, emkamatik, 18.9.2006.
- [28] EN 61000-4-7, March 1993. Electromagnetic compatibility (EMC). Part 4: Testing and measurement techniques. Section 7: General guide on harmonics and interharmonics measurements and instrumentation, for power supply systems and equipment connected thereto. IEC, CENELEC.

3 DEFINITIONS

Definitions in this document are in accordance with the referred standards.

The understanding of this document requires a general knowledge of electrical engineering and railway operation.

4 GENERAL INFORMATION OF RELATED INFRASTRUCTURE

This chapter gives a short introduction to traction power supply systems and track signalling circuits in Norway and Sweden. More specific data about the infrastructure is given as information in APPENDIX 1: Infrastructure data and related information.

4.1 General

In Norway and Sweden the earth resistivity is high in comparison to most of the rest of Europe. This has direct an effect on traction power supply design to avoid disturbing other electrical systems.

4.2 Norway

In Norway there are 2500 km of electrified railway (2004). The network around the capital Oslo is meshed with both double and single track lines. Around this centre there are long single track lines to other parts of the country. The Norwegian single-phase network is much weaker than in rest of Europe. In some areas the overhead contact line impedance is so large that changes in the power demand from one train may cause voltage variations up to some kilovolts. Both tap changer vehicles, phase controlled vehicles and inverter vehicles with and without filters operate in the network.

The power supply system is of the type 15 kV, 16.7 Hz. It is synchronized with the 50 Hz national grid, i.e. a decentralized system. There is however a small centralized system in the Oslo area consisting of a 55 kV, 16 2/3 Hz single-phase high voltage transmission line fed by one small hydro power station. This system is connected to the contact lines system via 5 substations (which can be located together with rotary converters).

Apart from the small centralized system the power is fed into the traction power supply system by rotary and static (power electronic) converter stations, which convert the energy from 50 Hz, three-phase, to 16 2/3 Hz, single-phase. The number of active converter units in each converter station is adapted to the hourly variation in load demand to allow maintenance and reduce the losses. There is one small hydro power station feeding directly to the overhead contact line system. In normal operation there is often a one-to-one relation between one converter station capacity and load demand from one train. Due to this, low frequency oscillations have often caused severe problems when new vehicles have been introduced.

In normal operation the system is interconnected between the feeding points, but in order to maintain both rail tracks and contact line, sectioning of the system is a common operation mode.

At present, the booster transformer (BT) system, with or without return conductors, is the main feeding system for contact lines in Norway. However, Norwegian National Rail Administration plans to build autotransformer (AT) systems for main long distances lines. There are also some series capacitances and one shunt capacitor in the single-phase network in order to reduce inductive contact line impedance, strengthening the voltage and feeding reactive power. The return path for the traction current, regardless of system and apart from

return conductors or any extra earth conductors, always comprise both rails, with exception of stations where single rail track signalling circuits occurs.

On electrified lines AC track signalling circuits are used, either double rail or jointless. Most common are 95 and 105 Hz uncoded track signalling circuits.

4.3 Sweden

In Sweden there are 9 543 km of electrified railway (2004). The railway network is meshed except for the northern part of Sweden. Most of the lines are single track lines except for lines close to Stockholm and the lines between the cities Stockholm, Gothenburg and Malmö.

The power supply system is of the type 15 kV, 16.7 Hz. The system is decentralized and synchronized with the 50 Hz national grid. The power is fed into the traction power supply system by converter stations, which convert the energy from 50 Hz, three-phase, to 16 2/3 Hz, single-phase. The converters are of both rotary and static (power electronic) type. The number of active converter units in each converter station is adapted to the load.

In order to reduce the number of converter stations, the contact overhead line system is also fed by a 132 kV system (a two-phase 2 x 66 kV system with directly earthed midpoint) with transformer substations. This system is used from the middle to the northern parts of Sweden. There is no power generation connected directly to the 132 kV system. The system is fed from transformers connected to the 15 kV 16,7 Hz busbars at the converter stations.

The two feeding systems for contact lines in Sweden are; BT-system (booster-transformer system) with one or two return conductors and AT-system (auto-transformer system). Sometimes also a strengthening wire (reinforcement wire, booster wire) occurs. This is more common in the northern part of Sweden, and this type of reinforcement wire is always used on AT-systems. Its objective is to lower the impedance. Sometimes an additional earth wire is used. This type of earth wire is planned to become standard on AT-system lines. A combined AT/BT-system is currently under investigation for introduction (a first small installation is made).

Most of the railway lines are fed from both ends (double sided feeding). Due to the high earth resistivity booster transformer systems with return conductors are mainly used, when not autotransformer systems are implemented, due to EMC requirements. This causes normally higher line impedance than in the central and south of Europe, where the return current can use the rails and earth all the way to the feeding point. The system is relatively weak with rather high voltage drops.

In Sweden only DC track signalling circuits are used (radio block occurs on none electrified low traffic lines).

Only one of the rails, the S-rail, is used for the return path of the traction current. This is regardless of what type of feeding system that is being used (BT- or AT-system). The other rail is always isolated, I-rail, and is used for the DC track signalling circuits.

5 SPECIFIC REQUIREMENTS REGARDING SAFETY, SAFETY SYSTEMS AND THIRD PARTY

Safety related requirements are requirements in section 5.1, Safety with respect to electricity, and 5.2, Track signalling circuits. Section 5.4, Telecommunication disturbances and psophometric currents, is regarded as third party requirements. Section 5.3, Radiated interference, can be regarded as both safety requirements and third party requirements. The use of the requirements in section 5.3 for old vehicle must be decided on a case to case basis.

5.1 Safety with respect to electricity

5.1.1.1 Information

SWEDEN:

If the vehicle is designed such that it is possible to climb up on the roof of the vehicle without difficulty and without additional means, the Swedish Railway Authority will define restrictions for parking the vehicle under live overhead contact line.

5.1.1.2 Requirements

Requirements are in accordance with EN 50 153:

The rolling stock shall be designed such that it is possible to operate the electrical installations in accordance with the following regulations:

NORWAY:

Any valid regulation from Directorate for Civil Protection and Emergency planning (DSB) must be followed.

Information can be found at: <http://www.dsb.no/>

SWEDEN:

The rolling stock shall be designed such that it is possible to operate the electrical installations in accordance with the following regulations: National Electrical Safety Board (Elsäkerhetsverket) regulations for operations of electrical installations.

Information can be found at: <http://www.elsakerhetsverket.se/>

If there is any accessible electrical equipment on the roof of the vehicle, it shall be possible to connect the grounding and short-circuiting tools used by the Swedish Railway Authority to earth points on the electrical equipment. Otherwise the vehicle must have own grounding tools. According to Elsäkerhetsverket, grounding via a transformer is not allowed.

EN 50 110-1 “Operation of electrical installations” is applicable to work activity on Swedish railway electrical installations with some exceptions and applications to overhead contact line.

NORWAY AND SWEDEN:

Necessary information about disconnection and grounding of rolling stock either as labels on vehicles or as readily understandable manuals in each vehicle is required in order to handle deviation situations. This requirement does not apply to information which is obvious or can be assumed to be common knowledge for those who do the specific tasks.

5.1.1.3 Verification

Verification shall be made by conformity statements that the rolling stock fulfils standards and regulations.

5.1.1.4 Documentation

The verification shall be presented in a report.

5.2 Track signalling circuits

NOTE:

The limits and requirements in this chapter, chapter 5.2, are under investigation for Norway and shall be treated accordingly.

Valid requirements and procedures for Norway can be found in “Characteristics of infrastructure”, Document JD 590, section 5:”Signalling and train control system”, by the Norwegian National Rail Administration.

5.2.1.1 Information

NORWAY:

Mainly track circuits of 95/105 Hz are used. On newer line sections, FTGS track circuits operating at 4.75-6.25 kHz and 9.5-16.5 kHz are used. The track is normally welded, but booster transformers may require isolated gaps in the rails to ensure correct function of the BT. Impedance bonds for 95/105 Hz may be used to allow return current to pass by insulated joints used for separating track circuits. DC track signalling circuits occur only at none electrified railway stations and one electrified railway station. At some lines no track signalling circuits are used.

The following track circuits are currently used in Norway:

- DC track circuits: Insulated rail joints
- 95/105 Hz track circuit: Insulated rail joints, frequency 95 and 105 Hz
(Also called 100 Hz track circuit)
- TI 21 (Adtranz): Jointless track circuit, frequency 1.5 – 2.6 kHz.
- FTGS (Siemens): Jointless track circuit, frequency 4.7 – 16.5 kHz

SWEDEN:

Only DC-track signalling circuits exist on electrified lines in Sweden. This means that there is always an isolated rail and a conducting rail for the return current. At some none electrified low traffic lines radio block systems are used.

The DC track circuits are installed in such a way that their susceptibility to interference currents is comparably low. This means that only two credible mechanisms have been identified by which an electric vehicle is capable of generating excessive DC interference currents:

1. Transformer inrush. Low levels can be achieved by a proper design of the main transformer.
2. Ice on the overhead contact wire. It is recognised that it may not be feasible to design a rail vehicle in such a way that compliance can be guaranteed at all ice conditions.

A third cause can be faulty conditions in the vehicle.

5.2.1.2 Requirements

General requirements for the vehicle and the signalling equipment are in accordance with EN 50 121-3-1 and EN 50 121-4.

All requirements below are applicable for one vehicle and for the maximum configuration of vehicles (i.e. multiple units) for which the approval must be valid.

NORWAY:

Emitted interference currents must not exceed the values of tables 5-2 and 5-3. The values are applicable to a complete train.

The vehicles must be equipped with interference monitoring systems for the 95 and 105 Hz track circuits. The monitoring system must automatically open the main circuit breaker if the 2 A monitoring trip level is exceeded.

Please notice that operating experience indicates that lower limits may be required in some frequency ranges on certain line sections. These requirements are under consideration. Norwegian National Rail Administration (NNRA) may on some route sections permit slightly excessive interference currents for some frequencies. Based on documentation for the noise current spectrum of the vehicle, NNRA will decide whether or not it is compatible with the route sections in question.

Table 5-2: Track circuit interference, Norway

System	Centre frequencies	Bandwidth	Time	Limit value	Requirements for monitoring
DC track circuits	No specific requirements				
95 and 105 Hz track circuits	95 Hz and 105 Hz	-3 dB at 92 Hz and 98 Hz, and at 102 Hz and 108 Hz	1 s	1 A	FFT with 1 Hz resolution. Trip level at 2 A RMS for any bin in the band
TI21 track circuits	Channel A: 1682 Hz and 1716 Hz Channel B: 2279 Hz and 2313 Hz Channel C: 1979 Hz and 2013 Hz Channel D: 2576 Hz and 2610 Hz Channel E: 1532 Hz and 1566 Hz Channel F: 2129 Hz and 2163 Hz Channel G: 1831 Hz and 1865 Hz Channel H: 2428 Hz and 2462 Hz	-3dB at ± 6 Hz from centre frequencies. -20 dB at ± 30 Hz from centre frequencies	1.5 s	<i>See note 1</i>	-
FTGS 46	Centre frequencies: 4.75 kHz 5.25 kHz 5.75 kHz 6.25 kHz	-3 dB bandwidth: 200 Hz 206 Hz 214 Hz 220 Hz <i>See note 2</i>	40 ms	1 A	-
FTGS 917	Centre frequencies: 9.5 kHz 10.5 kHz 11.5 kHz 12.5 kHz 13.5 kHz 14.5 kHz 15.5 kHz 16.5 kHz	-3 dB bandwidth: 360 Hz 380 Hz 400 Hz 425 Hz 445 Hz 470 Hz 490 Hz 510 Hz <i>See note 2</i>	40 ms	0.5 A	-

Note 1: The bandwidth definitions of the TI21s are from the BR Group Standard GS/ES 1914. This standard specifies a limit of 100 mA, but this is probably not true for TI21s installed in a 16 2/3 Hz environment. The number of channels used in Norway is under investigation (i.e. how many of the 8 channels are actually used in Norway)

Note 2: Attenuation at adjacent channels: max. 30 dB.

Table 5-3: Broad-band interference, Norway

Frequency band	Limit value	Time	Calculation method
TDB – 7 kHz <i>See note 3</i>	1 A RMS	1 s	FFT with 8 1/3 Hz resolution (120 ms time window) followed by 1 s moving RMS along the time axis of each FFT bin. The limit value applies per FFT bin.
7 – 9 kHz	0.5 A RMS	1 s	
> 9 kHz	0.33 A RMS	1 s	

Note3: The lower frequency limit is currently under investigation and is to be decided (=TBD).

Resistance between wheels of a wheel set must be according to UIC512:1979 ($< 0.1 \Omega$).

SWEDEN:

Regarding requirements on the impedance between wheels through wheel axles, see BVF 544.14002, Requirements on safe short circuit of track signalling circuits (only published in Swedish: “Säker kortslutning av spårledning”).

Direct-current track circuits can be affected by traction current in the frequency range 0 - 2 Hz. The traction current of the vehicle, with the exception of the inrush current of the transformer, shall not exceed 25 A in the frequency range 0 - 2 Hz. The DC-component of the inrush current of the locomotive/train, or rather train transformer/s, must not exceed 25 A for more than 1.5 seconds.

The limits given above are applicable for each unit of a train set and for any combination of units and the maximum configuration of units for which the approval must be valid.

In order to keep control of the DC interference levels caused by ice on the overhead contact line or faulty conditions in the vehicle, the vehicles must be equipped with an Interference Monitoring System for DC currents. The DC Interference Monitoring System must comply with the following requirements.

Technical Requirements – Monitoring System for DC Interference Currents

General Functional Requirements – Monitoring System for DC Interference Currents

The monitor must give a warning to the driver, and ramp down the tractive effort within 1-2 s, if the DC component of the line current exceeds 25 A for more than 1.5 s.

The monitor must open the main circuit breaker if the DC component of the line current exceeds 25 A for a total of 8 s or more (i.e., after an additional time of 6.5 s).

The 1.5 s and 8 s time counters must have decrement rates equal to the increment rates, i.e., they must not be immediately reset if the DC level goes below 25 A for a short time. If, for example, the DC level goes below 25 A for 0.5 s and then back above 25 A, then the counters must be back at their original value in max. another 0.5 s.

The monitor may be inhibited for up to 2 s when a close-order is given to the main circuit breaker.

The monitor must have a self-test function that is activated every time the vehicle is started up. The self-test system must inject the equivalent of 25 – 30 A DC in a separate winding on the current transducer, and check the correct operation of the monitor.

Specific Requirements – Monitoring System for DC Interference Currents

Current measurement:	Hall-effect transducer	
Signal conditioning:	Adequate anti-alias filters must be used	
Low-pass filter:	-3 dB point:	≥ 2 Hz
	Filter order:	$\leq 4^{\text{th}}$ order
Moving average integration time:	$n \times 60$ ms, $n \leq 4$	
Threshold level:	± 25 A DC	
Time counters:	1.5 s	
	8 s	
Output signals:	1.5 s:	Warning to the driver Tractive effort ramp down order
	8 s:	Open the main circuit breaker
Input signals:	Inhibit for 2 s	
	Perform self-test	
Configurable parameters:	Threshold level (nominal value: 25 A)	
	Time counter thresholds (nominal values: 1.5 s and 8 s)	
	Time counter decrement rates (nominal values: same as the increment rates)	

Safety Requirements – Monitoring System for DC Interference Currents

The monitoring system must meet Safety Integrity Level 2 for low demand mode of operation, according to EN 50 128.

The monitoring system may be integrated with the control system for the 4-quadrant line converters, or any other vehicle control subsystem. I.e., it need not be a stand-alone system.

Example – Monitoring System for DC Interference Currents

This section is given for information only.

Figure 5-1 below shows an example of a functional block diagram of a monitor designed according to the present specification.

Figure 5-2 shows the signals in the case of an exceedance of the 25 A limit lasting for more than 8 s (left curves), as well as an example in case the DC level of the line current fluctuates around the 25 A limit (right curves).

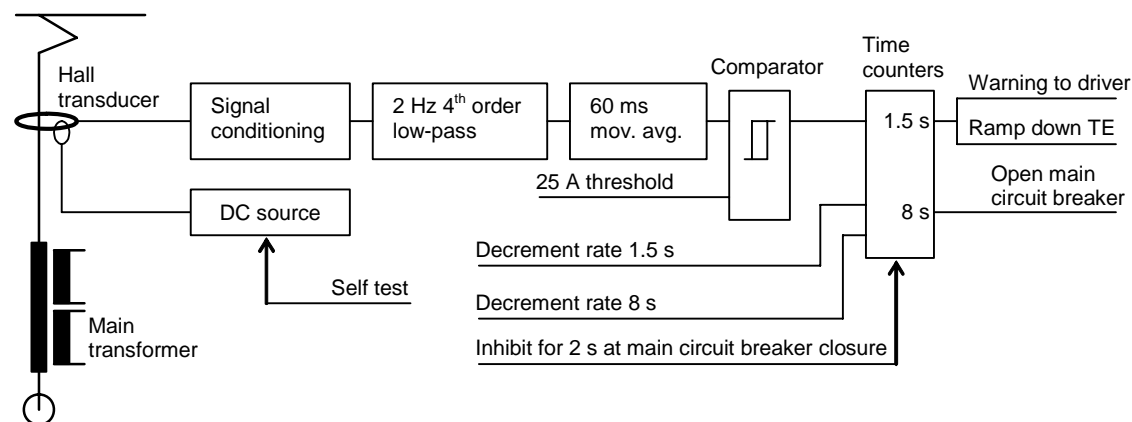

Figure 5-1: Monitoring system (example).

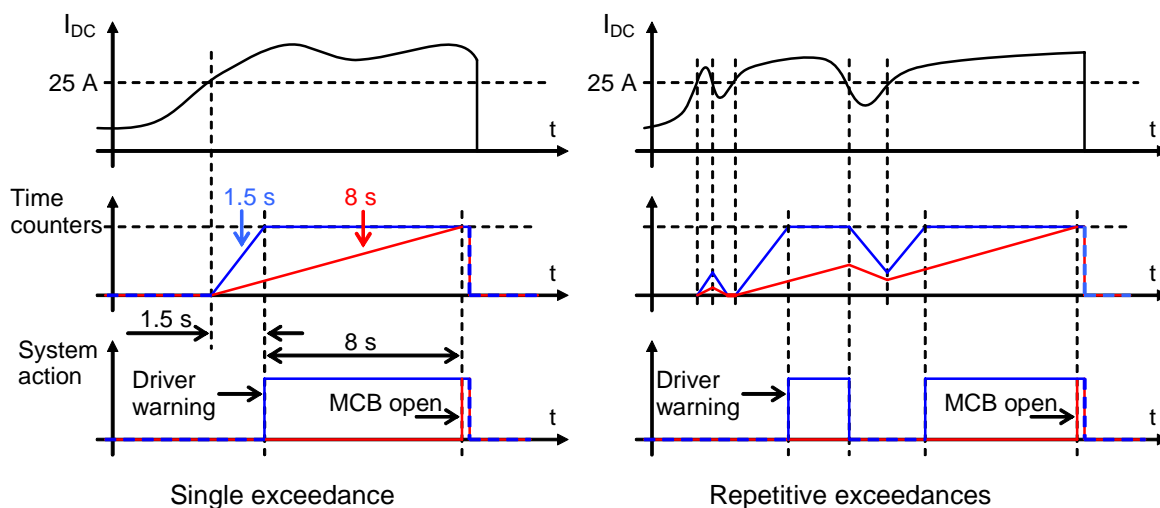

Figure 5-2: Examples of signals and system response.

5.2.1.3 Verification

Verification of general fulfilment of the requirements in EN 50 121-3-1 shall be made by the vehicle provider or the operator taking a vehicle in operation. Verification shall be made in accordance with the standard.

NORWAY:

Verification shall be done by test runs with measurement equipment being installed in the vehicle, on a closed track between to substations (converter stations) driving in one direction and performed both close to and at long distance from the substations. The tests shall be performed both in the normal operation mode with all traction modules being active (5 times), and in all relevant degraded operation modes with one or more modules deactivated (2 times each).

Each test run shall include the cycle described in figure 5-3, below.

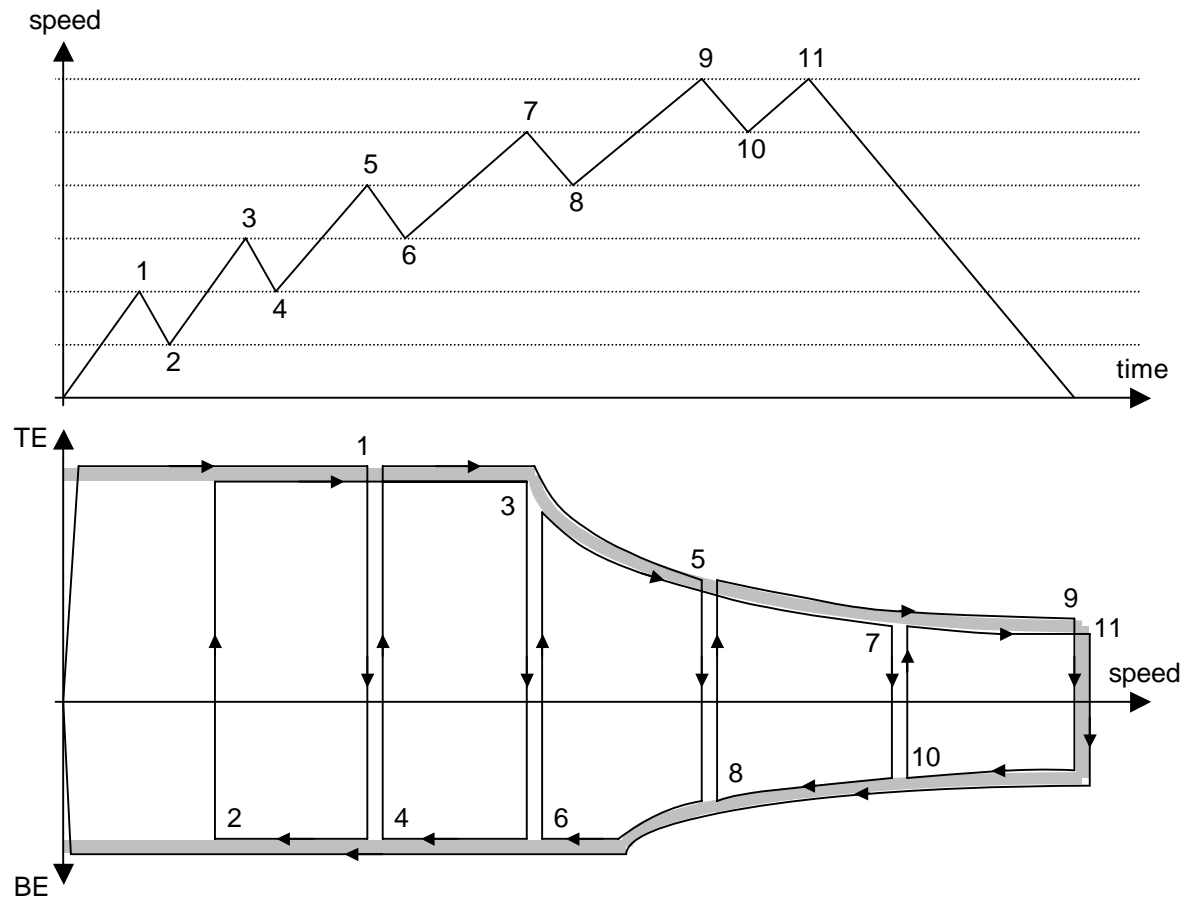

Figure 5-3: Suggested train operation for electrical tests. Upper curve: Generic speed profile, lower curve: 'Looping' of the tractive and electrical braking effort through the TE/BE diagram by switching as quickly as possible between maximum traction and maximum electric braking.

The signal processing of the recorded line current signals shall be according to the following table:

Table 5-4: Signal processing to measure harmful frequencies for Track circuit interference, Norway

System	Centre frequencies f_C	Suggested signal processing	Limit value
95 and 105 Hz track circuits	95 Hz and 105 Hz	2·2 nd order Butterworth band pass filters, -3dB at each $f_C \pm 3$ Hz, followed by moving RMS, time window = 1 s <i>see note 4</i>	1 A
T121 track circuits	1682 Hz and 1716 Hz 2279 Hz and 2313 Hz 1979 Hz and 2013 Hz 2576 Hz and 2610 Hz 1532 Hz and 1566 Hz 2129 Hz and 2163 Hz 1831 Hz and 1865 Hz 2428 Hz and 2462 Hz	Band pass filter with a rejection of ≤ 3 dB at ± 6 Hz from centre frequencies, and ≤ 20 dB at ± 30 Hz from each centre frequency, followed by moving RMS, time window 1.5 s <i>see note 5</i>	TBD
FTGS 46	f_C : 4.75 kHz 5.25 kHz 5.75 kHz 6.25 kHz f_{BW} : 200 Hz 206 Hz 214 Hz 220 Hz	2·2 nd order Butterworth band pass filters, -3 dB at each $f_C \pm f_{BW}/2$ Hz, followed by moving RMS, time window = 40 ms	1 A
FTGS 917	f_C : 9.5 kHz 10.5 kHz 11.5 kHz 12.5 kHz 13.5 kHz 14.5 kHz 15.5 kHz 16.5 kHz f_{BW} : 360 Hz 380 Hz 400 Hz 425 Hz 445 Hz 470 Hz 490 Hz 510 Hz	2·2 nd order Butterworth band pass filters, -3 dB at each $f_C \pm f_{BW}/2$ Hz, followed by moving RMS, time window = 40 ms	0.5 A

Note 4: 2nd order filters are based on the assumption that the receivers of these track circuits are electromechanical vane relays. This however should be checked and the issue is under investigation– it is important that the filter rejection at 100 Hz becomes right.

Note 5: Much work has been spent in the UK in order to design digital filters with the best possible match to these limits, and many proposals exist. It is suggested that the design of filters is left to the applicants. It is likely however that the -20 dB figure could actually be somewhat more – Final value is under investigation (TDB = To Be Decided).

Regarding signal processing to measure harmful frequencies for broad-band interference see table 5-3.

SWEDEN:

Verification shall be made by measurements under normal operation (no frosty lines). Measurements shall be performed on the primary current of the locomotive or train or train set. The transducer must handle the frequencies from DC and upwards. Measurements shall be performed with instrumentation having a sampling frequency of at least 1 kHz (0.4 kHz anti-aliasing filter or similar). The DC-component shall be calculated as the mean value over one period of the fundamental, moving average calculation. Verification shall be performed

by measurements when operating the vehicle under normal condition, e.g. together with other tests, see chapter 6 and 7, and by inrush current tests, see below.

Inrush current – practical test

The tests shall be performed at a location where the short circuit current is greater than or equal to 20 kA, i.e. $I_k \geq 20 \text{ kA}$ on a single track line. The train set shall be placed beyond the first booster transformer, counting from a converter station (NOTE: this is NOT the same situation as for the AC inrush current tests, see clause 6.7. The test specified here implies the test location to be at Ockelbo converter station with all converters in operation and all other converter stations connected to the 132 kV system. Other tests sites with scaling of the limit are under investigation.)

The tests shall be performed with the maximum configuration of the vehicle (i.e. maximal number of units in multiple operation for which the approval must be valid). At least 20 trials of breaker closures shall be performed, preferably more. All trials must be within limits for acceptance.

Measurements shall be performed with instrumentation with a sampling frequency of at least 1 kHz (0.4 kHz anti-aliasing filter or similar). The DC-component shall be calculated as the mean value over one period of the fundamental, moving average calculation. The transducer must handle the frequencies from DC and upwards. The whole course of the inrush current shall be recorded.

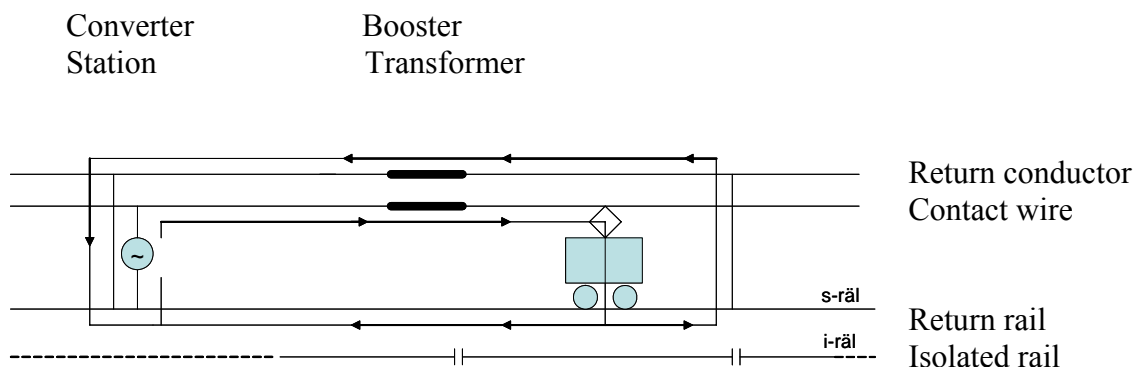

Figure 5-4: Train position at practical inrush current test. For numerical values of transformers see Appendix 1, section A1.2.3, A1.2.4 and A1.5.6.

Monitoring System for DC Interference Currents

Verification of the Monitoring System for DC Interference Currents shall be a conformity statement that the requirements are fulfilled.

5.2.1.4 Documentation

Documentation shall be a conformity statement and documentation of performed tests.

5.3 Radiated interference

5.3.1.1 Information

Conformance with EN 50 121 is the basis for new constructions and upgrading of infrastructure systems.

5.3.1.2 Requirements

NORWAY AND SWEDEN:

Requirements are in accordance with EN 50 121-2 and EN 50 121-3-1. Deviations, based on further evaluation, may be acceptable on a case-to-case basis.

5.3.1.3 Verification

Verification shall be performed by tests in accordance with EN 50 121-2 and EN 50 121-3-1.

5.3.1.4 Documentation

Documentation shall be a conformity statement and documentation of performed tests.

5.4 Telecommunication disturbances and psophometric currents

NOTE:

The limits and requirements in this chapter, chapter 5.4, are under investigation for Norway and shall be treated accordingly.

Valid requirements and procedures for Norway can be found in “Characteristics of infrastructure”, Document JD 590, section 6: “Telematic applications”, by the Norwegian National Rail Administration.

5.4.1.1 Information

Interference with digital systems such as PCM, ISDN, etc is not yet covered in this document. This is a field for which more work will be done. Information regarding GSM-R can be found in EIRENE standards from UIC.

The harmonics in the traction current of a railway system may induce noise in conventional analogue telecommunication system. The acceptable level of noise on conventional analogue telephone lines is specified by ITU-T. The limits in this document refer to the psophometric weighted traction current defined as:

$$I_{pe} = \frac{1}{P_{800}} \sqrt{\sum_{n=1}^{\infty} (h_f \times P_{fn} \times I_n)^2}$$

where $h_f=1$, which is the equivalent psophometric current measured or calculated for interaction with a telephone line as a cable. P_{fn} is in accordance with ITU-T. For values of P_{fn} see Appendix 9.

NORWAY AND SWEDEN:

The different limits in the two countries are due to the different railway line feeding systems. In Sweden there is always one or two return conductors used in booster transformers systems (there are only two lines without return conductor), whereas in Norway, booster transformer systems without return conductors are most common.

5.4.1.2 Requirements

All requirements below are applicable for one vehicle and for the maximum configuration of vehicles (i.e. multiple units) for which the approval must be valid.

NORWAY AND SWEDEN:

In case of a fault on the vehicle, for instance when one or more of the traction modules or filters is/are disconnected and the increase of the psophometric current is less than 6 dB, the vehicle is allowed to be driven to the nearest workshop. For such a case the limits below are doubled. If this demand can not be fulfilled, the vehicle shall be transported in a non-working condition.

NORWAY:

Psophometric electrical noise in the contact wire, generated by train, must not exceed 1.5 A. The value refers to the 99%- percentile of the measured psophometric current.

SWEDEN:

The psophometric weighted traction current must not exceed 1.65 A when the train is fed from a rotary converter or a modern static PWM converter with a relatively low harmonic content in the output voltage. The value refers to the 99%- percentiles of the measured psophometric currents.

5.4.1.3 Verification

NORWAY AND SWEDEN:

Verification shall be done by test runs (measurement in vehicle) on a closed track between two substations (converter stations) driving in one direction. Measurements shall be performed both close to and at long distance from the substations. Please note that this test requirement differs from the test requirements specified for the requirements in chapter 6.

The tests shall be performed both in the normal operation mode with all traction modules being active (5 times), and in all relevant degraded operation modes with one or more modules deactivated (2 times each).

Each test run shall include the cycle described in figure 5-1, under section 5.2.1.3 above.

As an alternative, the following test cycle, which is the same as for many of the power supply tests, see section 7.3, can be discussed:

- Acceleration from standstill to max speed (given by train or infrastructure) with maximum tractive effort.
- Running at max speed in 10 to 20 seconds
- Braking to max speed minus approximately 40 km/h with maximum electric braking effort
- Maximum acceleration back to max speed
- Braking with maximum electric braking effort to standstill.

See also chapter 7.3, Tests regarding compatibility with the power supply.

For each lap the 99%-percentile shall be calculated. See also EN 50 121-3-1, Annex A (informative).

5.4.1.4 Documentation

The results shall be documented in a technical report. The report shall for each test lap contain the 99%-percentile and a plot of psophometric current versus speed.

6 REQUIREMENTS REGARDING COMPATIBILITY WITH THE POWER SUPPLY AND OTHER ISSUES

In this chapter all requirements regarding compatibility between vehicles and the power supply are compiled. All requirements, when applicable, are valid for one vehicle and for the maximum configuration of vehicles (i.e. multiple units) for which the approval must be valid.

This document describes requirements and infrastructure as is. The infrastructure managers are continuously trying to improve the infrastructure in Norway and Sweden. New or newly imported old rolling stock must not however require changes in the existing infrastructure and rolling stock in order to operate properly.

6.1 Line Voltage

6.1.1 Levels

6.1.1.1 Information

The values in this section refer foremost to stationary or quasi-stationary conditions. For dynamic effects see also section 6.5, Harmonics and dynamic effects.

NORWAY AND SWEDEN:

Under normal operating conditions (in accordance with the definition in clause 3.16 in EN 50 163:2004), the traction power supply complies with the requirements for minimum and maximum voltage given in clause 4.1 in EN 50 163:2004, and for $U_{\text{mean useful(zone)}}$ and $U_{\text{mean useful(train)}}$ for conventional TSI lines and classical lines given in clause 8 of EN 50 388:2005. Exceptions and specifications are given below.

The nominal voltage is 15 000 V. The voltage at the feeder station busbar is usually adjusted to 16.5 kV independent of load (below max load), or to 16.5 kV with a gently declining characteristic as a function of inductive current in order to improve load-sharing of reactive power between converter stations. Declining characteristic means that the voltage is controlled in such a way that the voltage will drop linearly as a function of the inductive load, and such that the voltage will decrease about 2-5% from 16.5 kV at full and purely inductive load. If the total capacity of a converter station is low, e.g. because a converter unit is out of service, a further reduction of the voltage is normally added by means of a current limitation function at and above the rated power of the converters.

There are no requirements for the unspecified period in time in clause 4.1 in EN 50 163:2004 for maximum voltage, if the increased contact line voltage is caused by regenerative braking of rolling stock. This implies that a train may continuously generate up to U_{max2} during regenerative braking.

The instantaneous values for the line voltage can however be very high. Due to the high harmonic content, see section 6.1.3, a crest factor above 1.8 can occur giving peak values of up to about 32 kV.

NORWAY:

In Norway the following infrastructure classification is made due to weak power supply:

- Class V1, default: minimum train voltage in accordance with clause 4.1 in EN 50 163:2004
- Class V2: minimum train voltage $U_{\min 2}=10000$ V and $U_{\min 1}=11000$ V in accordance with definitions in clause 4.1 in EN 50 163:2004. The reason for this voltage reduction is older rolling stock which do not have an efficient current limitation as a function of pantograph voltage, and it can be found at sections where the distances between traction power supply feeding points is long

6.1.1.2 Requirements

NORWAY AND SWEDEN:

Rolling stock must be able to operate under the voltage conditions given above and are not allowed to generate voltage outside these limits. See also section 6.4.2, Current or power control at low voltage.

6.1.1.3 Verification

NORWAY AND SWEDEN:

Rolling stock ability to withstand the voltage levels must be tested in accordance with EN 50 215:1999, clause 9.15.

Practical short circuit tests on a line as described in EN 50 215:1999, clause 9.15.4 shall not be performed. These tests are to be performed as factory tests instead. See also chapter 6.8, Regenerative braking, and its reference to EN 50 388:2005, clause 12, regarding regeneration to a neutral section or a short circuit.

For more details about tests see chapter 7, Validation and tests, section 7.3, Tests regarding compatibility with the power supply.

6.1.1.4 Documentation

NORWAY AND SWEDEN:

Conformity statement and test report.

6.1.2 Frequency

6.1.2.1 Information

The values in this section refer foremost to stationary or quasi-stationary conditions. For dynamic effects see also section 6.5.1, Low frequency power oscillations.

NORWAY AND SWEDEN:

Synchronous frequency is within the variation given by EN 50 163:2004, clause 4.2

The traction power system frequency is synchronous with the national grid in Norway and Sweden, hence is then also dependent on variation in three-phase network frequency.

$$f_n = 16 \frac{2}{3} \text{ Hz}$$

Normally the frequency variation is ± 0.033 Hz and under special conditions the variation is ± 0.166 Hz due to frequency variations in three-phase network.

6.1.2.2 Requirements

NORWAY AND SWEDEN:

Rolling stock shall be able to operate under frequency variations in accordance with EN 50 163:2004, clause 4.2.

6.1.2.3 Verification

NORWAY AND SWEDEN:

Conformity statement.

6.1.2.4 Documentation

NORWAY AND SWEDEN:

Conformity statement.

6.1.3 Harmonics

6.1.3.1 Information

NORWAY AND SWEDEN:

THD (total harmonic distortion) is defined as:

$$THD_U = \frac{\sqrt{U_2^2 + U_3^2 + \dots + U_n^2}}{U_1}, n = 4, 5, 6, \dots$$

U_1 = fundamental harmonic voltage

U_n = various higher-order harmonics

The line voltage THD may exceed 0.3. Table 6-1 below gives a typical example of the statistical distribution of the voltage distortion parameters.

Table 6-1: Typical distribution of voltage distortion parameters

Parameter	Percentile		
	90%	99%	99.95%
Crest voltage	29.5 kV	31.2 kV	32.4 kV
Total RMS voltage	16.7 kV	17.0 kV	17.2 kV
16 2/3 Hz fundamental, RMS	16.4 kV	16.7 kV	16.9 kV
3 rd harmonic, RMS	3.4 kV	4.0 kV	4.7 kV
5 th harmonic, RMS	1.8 kV	2.7 kV	3.6 kV
7 th harmonic, RMS	0.4 kV	0.7 kV	1.3 kV
THD _U	0.23	0.3	0.34

The values of this table are based on approximately 20 hours of recordings made during tests with a locomotive on the Borlänge-Ludvika/Krylbo-Frövi-Eskilstuna line sections in Central Sweden, October 2005. Recordings and analysis by L. Buhrkall.

The values at the 99.95% percentile may be taken as worst-case, excluding short transients etc. Please notice that the highest levels of the low-order harmonics (3rd, 5th, and 7th) do not necessarily occur simultaneously.

Higher-order harmonic voltages exist but these are relatively small.

The harmonics specified above may have all possible angles. Typically, the phase angle of the 3rd harmonic is the opposite of that of the fundamental, such that the crest value of the line voltage becomes the highest possible. To a lesser extent, this is also the case with the 5th harmonic.

6.1.3.2 Requirements

NORWAY AND SWEDEN:

Rolling stock must be able to function satisfactory when the contact line voltage includes harmonic distortion as described above.

Limiting values for current harmonics for vehicles are specified in section 6.5.3 Current harmonics.

6.1.3.3 Verification

NORWAY AND SWEDEN:

Conformity statement and tests. Tests are specified in chapter 7, Validation and tests, section 7.3, Tests regarding compatibility with the power supply.

6.1.3.4 Documentation

NORWAY AND SWEDEN:

The results of the tests and documented function shall be presented in a technical report.

6.2 Neutral sections

6.2.1.1 Information

NORWAY AND SWEDEN:

Neutral sections are arranged at:

- most feeding points/stations – normally unenergized and floating
- most switching posts – normally unenergized and floating
- all coupling posts – normally energized if network is interconnected, otherwise unenergized and floating
- all series capacitances – normally unenergized and floating, (series capacitances exists only in Norway)

Temporarily sectioning of contact line network is necessary in order to do maintenance and is consequently a frequent mode of operation. In case of short circuit in a railway line, or special operation of the utility grid, sectioning of the network is also used.

Infrastructure is not equipped with automatic information about neutral section. Information is given to driver by optical signals along the line.

NORWAY:

The normal length is 90 m, but length down to 40 m and up to 350 m exists. In Norway neutral sections of 402 m length is planned for the future to avoid bridging by train with two current collectors.

SWEDEN:

The normal length is 180 m, but length down to 60 m exists. In railway yards neutral sections with lengths of down to 2 m can occur. The neutral sections are normally not earthed, but at narrow bridges and at construction or big maintenance work this may occur.

6.2.1.2 Requirements

NORWAY AND SWEDEN:

Requirements are in accordance with EN 50 388:2005, clause 5. Feedback of regenerative braking power should also be brought to zero when entering a neutral section.

6.2.1.3 Verification

NORWAY AND SWEDEN:

Verification shall be made by means of a technical description on how the vehicle behaves and how the driver shall behave when entering neutral sections. The description can include calculations and functional diagrams.

6.2.1.4 Documentation

NORWAY AND SWEDEN:

The verification shall be presented in a technical report.

6.3 Power factor

6.3.1.1 Information

The power factor, λ , in this section is defined as:

$$\lambda = \frac{P}{S}$$

Where

$$P = U_1 \cdot I_1 \cdot \cos(\varphi_1)$$

$$S = U_1 \cdot I_1$$

Hence, in this document:

$$\lambda = \cos(\varphi_1)$$

and concerns only the fundamental.

In many other cases apparent power is defined or measured as:

$$S = U_{RMS} \cdot I_{RMS}$$

which can give very misleading results if harmonics are present, and hence shall not be used.

At very long lines the application of a capacitive $\cos(\varphi)$ can lead to a network breakdown within the normal operation range of the line voltage at pantograph and consumed active power (figure 6-1).

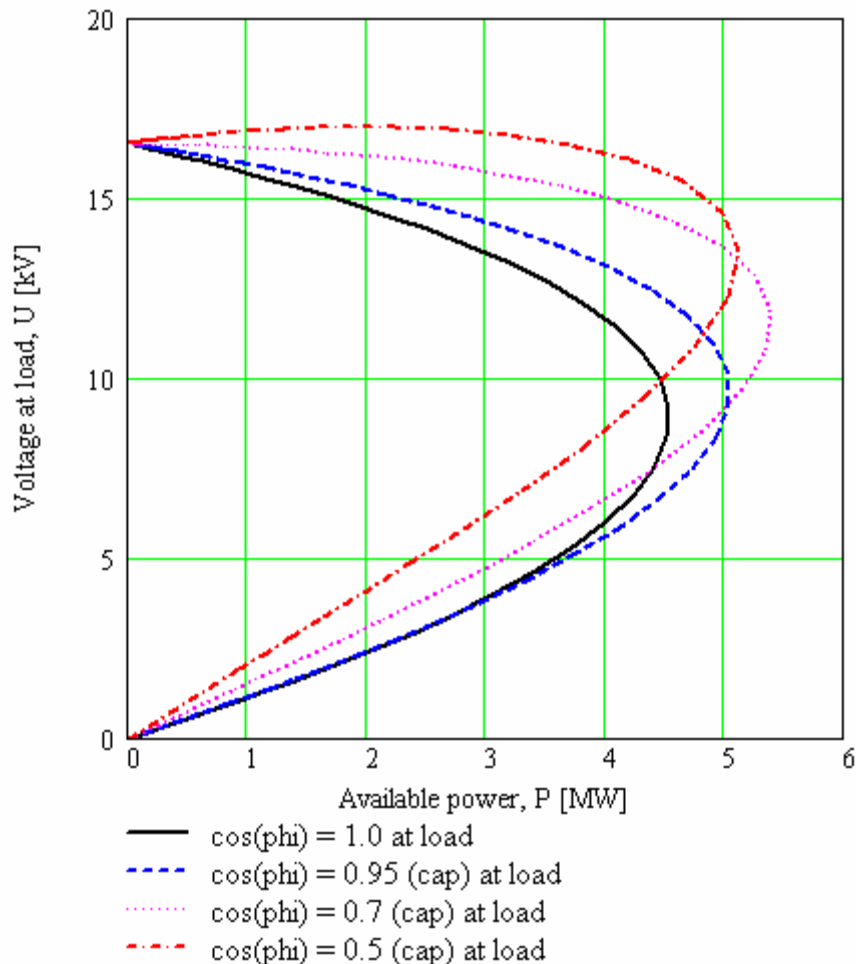

Figure 6-1 Principal diagram of voltage U versus available power P at the pantograph in a normal situation and when capacitive $\cos(\phi)$ is applied. The figure shows an example of a 60 km long single fed line. In reality the curves depend on the line impedance and the controller settings of the vehicle.

6.3.1.2 Requirements

NORWAY AND SWEDEN:

Requirements are in accordance with EN 50 388:2005, clause 6.

NOTE: Capacitive power factors could lead to over voltages, exceedance of power transfer stability limits, or other dynamic effects, and should be treated in accordance with clause 10 in EN 50 388:2005 (section 6.5.1 in this document). For voltages below 14 – 15 kV, however, it could be desirable with a certain amount of capacitive $\cos(\phi)$, provided that stability is maintained.

NOTE: Even if the power factor is allowed to decrease freely (inductively) during regeneration (electrical braking), according to EN 50 388:2005, clause 6, in order to keep the voltage within limits, it is required that the power factor is not inductive (below 0.95) when the voltage goes below 16.5 kV.

As an alternative to the requirements in EN 50 388:2005 the following figure for the requirements can be used (also in this figure the power factor refers only to the fundamental, as in EN 50 388:2005).

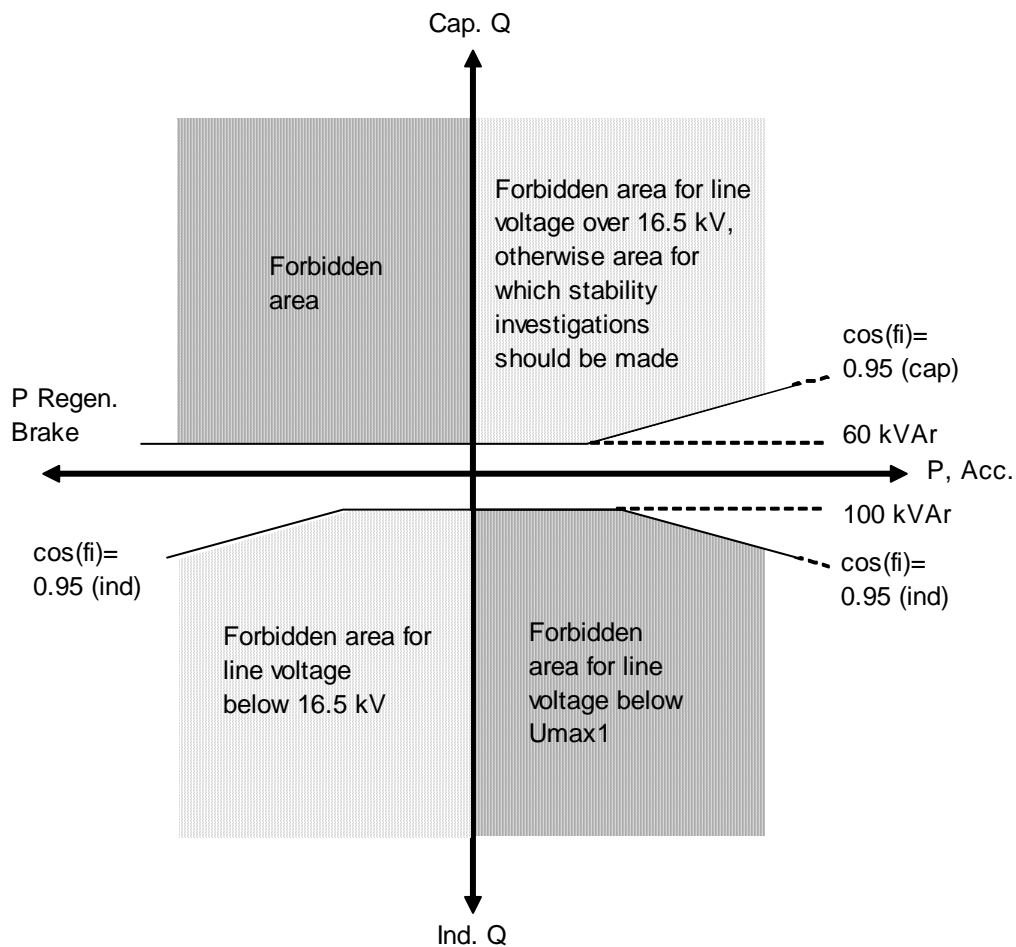

Figure 6-2 Allowed power factor for the fundamental. For the area that requires stability investigations see also clause 6.5, Harmonics and dynamic effects.

The figure is valid for all possible situations (all instantaneous RMS-values, but transients excluded) with the restrictions mentioned above. One exception is during icy condition on the overhead contact line. Under these conditions, a higher reactive current may be used at no or low power in order to maintain a continuous current for the inverter on the vehicles. Max 15 Arms inductive reactive current is allowed.

Using the figure means that the applicant does not have to do the calculations given in EN 50 388:2005, clause 6.2. The verification can be made by measurements, see section 6.3.1.3, below and chapter 7.3.

Both Norway and Sweden have exceptions from the general requirements stipulated in EN 50 388:2005 and in the draft of the High Speed TSI from June 2006:

- 1) Capacitive power factor is not allowed at voltages over 16.5 kV in Norway and Sweden, due to the risk that it becomes difficult or impossible for other vehicles to use regenerative braking because of high voltage on the overhead line.

(This exception is stipulated for Sweden in both EN 50 388:2005 and the HS TSI and for Norway in the draft of the HS TSI.)

- 2) In regeneration mode (electrical braking) the train shall not behave like a capacitor greater than 60 kVAr at any regenerative power, i.e. capacitive power factor is prohibited during regeneration. The exception of 60 kVAr capacitive reactive power is to allow the possibility to have filters on the high voltage side of the train/traction unit. These filters shall not exceed 60 kVAr capacitive reactive power at the fundamental.

(This exception is stipulated for Sweden and Norway in both EN 50 388:2005 and in the draft of the HS TSI.)

NOTE: The value 0.95 in the figure above is expected to be improved to 0.98 in the future for inductive power factor.

6.3.1.3 Verification

NORWAY AND SWEDEN:

The requirements shall be verified by calculations, using measured power factors at different operating conditions, in accordance with EN 50 388:2005, clause 6, 13 and 14. As an alternative, the verification can be made by measurement tests and the use of Figure 6-2. The conditions for measurements and tests are specified in chapter 7, Validation and tests, section 7.3, Tests regarding compatibility with the power supply.

6.3.1.4 Documentation

NORWAY AND SWEDEN:

The verification shall be presented in a technical report. The report shall include the calculations or a description of the calculations when calculations in accordance with EN 50 388:2005 have been made. Also measured values shall be presented in the report.

If the alternative method of the requirements and verification is being used the report shall include figures presenting the measured results. A description of the used instrumentation shall be included.

If $\cos(\varphi)$ control is used in the vehicle, the corresponding control characteristics shall be documented. If capacitive $\cos(\varphi)$ is applied in traction, the line power versus voltage diagrams as shown in figure 6-1 shall be included for lines with various line lengths / impedances.

6.4 Current limitation

6.4.1 Maximum current limitation

6.4.1.1 Information

NORWAY AND SWEDEN

Maximum allowable train current is given in EN 50 388:2005 Table 2 with specifications and exceptions as given below.

NORWAY:

Due to the mixture of strong and weak lines, the Norwegian power supply is divided into the following classes of maximum allowable train current (I_{\max}), applicable to trains equipped with automatic current limitation as function of contact line voltage in accordance with section 6.4.2 Current or power control at low voltage:

- Class C1: $I_{\max} = 1200$ A
- Class C2: $I_{\max} = 900$ A (given in Table 2 in EN 50 388:2005), default value
- Class C3: $I_{\max} = 700$ A

For older rolling stock without automatic current limitation, maximum allowable train current (I_{\max}) must be considered in each individual case.

Note that these limits are also valid for the regenerated currents when the vehicle is using regenerative braking, as in EN 50 388, Table 2.

Norwegian infrastructure is not prepared for automatic current selection.

Note that if voltage dependent current limitation is not used, voltages below the line voltage level requirements given in EN 50 163:2004 (see 6.1.1 Line Voltage Levels) may occur when collecting I_{\max} on some sections, even when no other trains are present in the section.

SWEDEN:

The value for Sweden in Table 2 in EN 50 388:2005, clause 7, is valid for vehicle drawing current in tractive mode. During regenerative braking the current can exceed this value, due to $\cos(\varphi)$ -control (if present) in order to keep the voltage within limits.

6.4.1.2 Requirements

NORWAY AND SWEDEN:

Requirements are in accordance with EN 50 388:2005, clause 7.

NORWAY:

The apparent power of the rolling stock must be adjusted to the requirements of the individual section and to the load demand by other rolling stock running in the network. Local power collection limits may be given when timetables are prepared.

6.4.1.3 Verification

NORWAY AND SWEDEN:

Verification shall be given statements of rated data of the vehicle and measurements of drawn current on a strong line. Measurements are specified in chapter 7, Validation and tests, section 7.3, Tests regarding compatibility with the power supply.

6.4.1.4 Documentation

NORWAY AND SWEDEN:

The verification shall be presented in a technical report where the test results shall be presented. The tests shall at least be presented in U-I-diagrams with the limits drawn in the diagrams for both traction and braking. As additional information, a U-P-diagram should be given.

6.4.2 Current or power control at low voltage

6.4.2.1 Information

No specific information

6.4.2.2 Requirements

NORWAY AND SWEDEN:

Requirements are in accordance with EN 50 388:2005, clause 7.

NOTE: The requirements in EN 50 388:2005, clause 7, are based on line current. Control based on power can be easier to realize and fulfils the basic requirements (avoid breakdown of voltage and let the vehicle find a stable working point) as well. Hence it is allowed for the applicant or manufacturer to design this control as a power limitation control, even though it is not strictly according to the standard. If the limitation is designed as a power control, the current shall not exceed the limits given in EN 50 388:2005, clause 7.2. It must however be stated how the limitation is designed.

6.4.2.3 Verification

NORWAY AND SWEDEN:

Verification shall be made by a technical description of how the requirements are fulfilled. Verification shall also be performed by tests on a weak single fed line by measuring the voltage and current. The tests are specified in chapter 7, Validation and tests, section 7.3, Tests regarding compatibility with the power supply.

6.4.2.4 Documentation

NORWAY AND SWEDEN:

The verification shall be presented in a technical report. The tests shall at least be presented in a U-I-diagram with the limits drawn in the diagram for both traction and braking. As additional information, a U-P-diagram should be given.

6.5 Harmonics and dynamic effects

6.5.1 Low frequency power oscillations

6.5.1.1 Information

NORWAY AND SWEDEN:

See Appendix A4.1.1 for the background of low frequency oscillations.

Both Norway and Sweden have a large number of rotary frequency converters feeding the railway network with 16 2/3 Hz from the public 50-Hz grid. These converters are synchronous-to-synchronous machines and have no damping windings on the motor side. Hence the pole angle oscillations – which have an eigen-frequency of about 1.6 ... 1.9 Hz – are poorly damped. This characteristic is very specific for both countries and leads to special requirements which may not exist in other networks. However, it is possible to meet these requirements as various projects have shown.

If an oscillation is excited, the rotor in the synchronous-to-synchronous converter oscillates relative to the synchronous frequency (rotates faster and slower than the synchronous speed in a cycle with the oscillation frequency), and the single phase voltage and frequency may vary from the stationary value (frequency oscillations up to and possibly above 1 % of f_n can be used as indicative values). This means that the zero crossings of the voltage may not be as predictable as indicated by the specified stationary frequency variation. Experience has showed that vehicles may have problems to work properly or at all when this type of oscillations occurs.

Periodic changes in active power in the single-phase network occurring at the eigen-frequency of the converter can be greatly amplified, typically 10 times, through the converter unit. This means that periodic changes in the active power at the single-phase side can cause 10 times higher power oscillations on three-phase side of converter. This may cause noticeable voltage

fluctuations and power oscillations in public utility grid. The eigen-frequency of the converters depends on the size of the converter unit, the number of units running in parallel, the characteristics of the utility network feeding the station, etc.

Oscillations are also expected to cause mechanical stress and degeneration of the converter units.

More information on dynamic behaviour of rotary converters is given in Appendix A5.

It is important to notice that the installed power of a train may in some cases reach or even exceed the rated power of a rotary or static converter. Low traffic density implies that the voltage controller in a vehicle and in the converter unit can work directly against each other in a one to one relation. Hence low frequency oscillations of about 3-4 Hz have also been observed together with static converters in some cases.

Long feeding distances and the correspondingly high line impedance can also lead to low frequency oscillations if the vehicle controllers are inadequately structured and parameterised.

By generating or consuming reactive power ($\cos(\varphi)$ -control), the line voltage at the location of the vehicle can be lowered or raised in a controlled manner, hence reducing the voltage drop along the line. However, this control strategy has the potential of creating low frequency oscillations in the feedback loop line voltage \rightarrow reactive power \rightarrow line voltage. The line impedance as well as the number of vehicles in a feeding section act as a gain factor in this loop.

NORWAY:

It is possible that the rail network in future will be divided into different classes based on low frequency oscillations and each class with different requirement.

6.5.1.2 Requirements

NORWAY AND SWEDEN:

The vehicles shall not cause low frequency oscillations, neither by feedback effects (including $\cos(\varphi)$ -control) nor by repetitive controller action. Any already excited oscillation shall be well damped. Furthermore, the vehicles must not obstruct damping of low frequency oscillations that have been excited by other vehicles or events in the network. These requirements must be assured for all relevant operational conditions, including maximum number of vehicles in a feeding section, and outage of a substation and single-side feeding. The precise conditions and consequently the parameters depend on the application of the vehicle (e.g. freight locomotives or rapid mass transit).

A train must have a stable behaviour close to a converter station with an installed power equal to or lower than the rated power of the train. The same train shall be stable at 60 km distance from the same substation on a line with single-side feeding.

The vehicle must be immune against the oscillations in such a way that its operation is not improperly influenced by oscillations caused by the vehicle itself, or by other vehicles or events in the network.

Repetitive controller action (e.g. in the adhesion control or line current limitation) must not take place with deterministic intervention frequencies between 1.0 and 2.0 Hz.

Feedback loop effects must not cause oscillations within the frequency range of 1.0 to 5.0 Hz. Such effects should in general also be avoided for other frequency ranges.

For new vehicles, a stability study according to EN 50 388:2005, clause 10 shall be performed in its relevant parts. It is recommended that the simulation results (step 10 of the compatibility process) are presented before the tests in the real railway system begin.

See Appendix A4.1.2 and A4.1.3 of this document for further information on stability studies.

NORWAY:

As described in EN 50 388:2005 section 10.2, numerical boundaries for each parameter may easily become very restrictive if they are to be sufficient in all cases, and these boundaries have not yet been developed.

As the properties of stability are a result of the co-operation between several systems, the Norwegian National Rail Administration has chosen to state only the issues that are emphasised when considering whether rolling stock have sufficient properties of stability:

- How often and for which reasons oscillation occurs: Experience shows that some oscillation in phase position for rotary converters may be difficult to avoid, e.g. when wheel slip and slide protection or protective relays are activated. When no extraordinary causes exist, such as the ones described above, the rolling stock is expected not to cause oscillations.
- Any oscillation that is initiated by the vehicle, by other vehicles, or by any event in the power supply, will normally be damped by the converters as shown in appendix A5. Vehicles must not react to an oscillation in a way that maintains the oscillation or obstruct the damping of the oscillation.
- The relationship between oscillations in 3-phase power and single-phase power at converter units: A large amplification indicates that the converter is exposed to power variations that excite oscillations in an unfavourable way.
- Oscillation amplitude for contact line voltage and/or power: Increased amplitude deteriorates the conditions for both existing and future rolling stock. A definite limit will be such that new or modified vehicles shall not cause worse maximum values than values existing today.

Numerical requirements for the vehicle-infrastructure interface are under investigation. Until this investigation has been finished, the requirements are as described above, **and the verification has to include measurements in the converter station.** A train operator and/or vehicle supplier seeking acceptance for a new vehicle must be prepared to carry out

comprehensive testing in cooperation with the Norwegian National Rail Administration, in order to determine the optimum settings of the control systems of the vehicle such that no problems occur.

SWEDEN:

The values below shall be treated as indicative values, not as absolute limits implying that everything is completely safe up to these limits. Different projects have shown that unfavourable oscillations can occur even below these limits. Due to the difficulties of defining precise and fixed acceptance criteria, acceptance must at present be based on a common understanding of the test results.

The indicative limits for power oscillations caused by repetitive controller action is 5% of the rated power of the train unit or 500 kW (the highest of these two values) for not more than 10 seconds, and not more than 1.5% of the rated power or 150 kW (the highest of these two values) for not more than 20 seconds. For durations longer than 20 s, the corresponding limit values are 1% or 100 kW. Values refer to RMS-values of the power oscillation. Transients can be excluded.

The indicative limits above can be applied also for feedback instabilities in control loops, with an additional condition that the RMS-value of the voltage must not oscillate more than 0.4-0.5 kV peak to peak in a sustained undamped oscillation for about 5 to 10 seconds. After that, the oscillation must be damped. Both the voltage and the power condition must be fulfilled. The requirement on the voltage is given by the risk of power oscillations at the converter station that are not noticed at the vehicle, in case the vehicle is designed with a constant power type of control strategy.

NOTE: For repetitive controller action (i.e. slip control) the oscillation is normally a broadband oscillation, whereas for feedback effects it is normally possible to identify a specific frequency. Hence the requirement regarding feedback instabilities, i.e. the voltage oscillation limit, is valid when an oscillation at a more or less constant frequency in the range of 1.0 – 5.0 Hz can be found in the RMS-value of the voltage.

6.5.1.3 Verification

NORWAY AND SWEDEN:

The verification shall be done by testing for typical operational as well as one or several worst case situations. These situations shall be as similar as possible to those investigated in the simulation study. A test plan according to EN 50 388:2005, clause 10, step 12, is required before starting the tests. The tests are specified in chapter 7, Validation and tests, section 7.3, Tests regarding compatibility with the power supply, and signal processing is described in section 7.4, Measurement instrumentation and methods.

NORWAY:

At present, additional measurements in the converter station are required to ensure proper low frequency behaviour. Details are given in chapter 7.3.6.1, Low frequency power oscillations.

6.5.1.4 Documentation

NORWAY AND SWEDEN:

The documentation consists of the simulation report and the test report. The simulation report shall point out the stability limit in terms of line impedance, number of vehicles and substation power rating, and show which oscillation frequency would be created if this stability limit is exceeded.

Note that the simulation report must be ready at the time of writing the test plan (see chapter 7.1, Pre-requirements).

The test results shall also be presented in a report. The report shall contain power, voltage and current plots versus time. It is recommended that also the DC-link voltage shall be plotted. The power plot shall both contain actual power and analysed power oscillations. The voltage plot shall contain the voltage and analysed voltage oscillations.

6.5.2 Electrical resonance stability

6.5.2.1 Information

NORWAY AND SWEDEN:

See Appendix A4.2.1 for the background of electrical resonance stability.

Both networks have similar and demanding conditions in view of resonance stability, since they include vehicles and static converters with partially large filters, a dedicated 132-kV transmission system (Sweden only, Norway has a small 55-kV system), long feeding distances between substations, and in the future an increasing amount of cables in the 15 kV network. Autotransformer systems also have a lower resonance frequency than other supply systems.

For values regarding line resonances see Appendix 1 section A1.5.9 and A1.5.10, which gives numerical values for booster transformer and autotransformer systems.

6.5.2.2 Requirements

NORWAY AND SWEDEN:

The relevant characteristic for resonance stability is the frequency response (or small signal behaviour) of the input admittance $Y(f)$ seen from the pantograph into the vehicle. If the real part $\text{Re}(Y(f))$ is negative at any frequency f , then the vehicle is capable of causing instabilities when combined with critical resonance points in the power supply system or other vehicles. These instabilities will appear as self-excited oscillations at the corresponding frequency f . In such a case, the vehicle is said to be “active”, otherwise it is “passive”.

Vehicles must be passive for all frequencies above the frequency f_g as defined below. This is the acceptance criterion as required by EN 50 388:2005, clause 10, step 7.

The criteria for electrical resonance stability are applicable for inverter vehicles only.

f_g is 90 Hz.

For all types of vehicles special attention must be taken if passive filters are used. For frequencies where the filters are capacitive the filters must be well damped and the filters must not produce overvoltages.

6.5.2.3 Verification

NORWAY AND SWEDEN:

Simulation of the frequency response $Y(f)$ for different operation points (typically zero power, maximum traction power, and maximum braking power). The upper frequency limit for evaluation of $Y(f)$ depends on the applied inverter and controller technology and has to be selected at least so high that no active behaviour can be expected beyond it.

No stability study for the full power supply system has to be performed, provided that the vehicle meets the requirements as defined above for inverter vehicles. For vehicles which do not meet these requirements, a full study according to EN 50 388:2005, clause 10 has to be performed by the vehicle manufacturer or by the infrastructure owner on the applicants costs.

For vehicles equipped with passive filter, the applicant must show simulations or calculations which confirm that the filters are well damped at frequencies where the filters are capacitive, and that there is no risk for resonances or overvoltages, according to EN 50 388:2005, clause 10.

Tests are to be performed in connection with other tests. The voltage shall be recorded and analyzed with respect to harmonics, see chapter 7, Validation and tests, section 7.3, Tests regarding compatibility with the power supply. In particular, this is valid for the mixed traffic tests with test runs in areas with heavy other traffic.

Special tests, where the vehicle input impedance as function of the frequency is to be measured, are under investigation.

6.5.2.4 Documentation

NORWAY AND SWEDEN:

Simulation report and validation/test report.

Numerical data giving the frequency response $Y(f)$ has to be delivered in a generally used electronic format (ASCII files, Excel, Matlab), with a maximum resolution of 1/3 Hz from the line frequency up to 1000 Hz or sample frequency of the converter control, whatever is the higher frequency. The choice of using the sampling frequency comes from the experience that some vehicles have had problems above the Nyquist frequency.

The circuit diagram and component parameters of the line-side circuits of the vehicle must be included in the report for comparison purposes.

Note that the simulation report must be ready at the time of writing the test plan (see chapter 5, pre-requirements).

Evaluation of the voltage and the harmonics measured during the tests shall be presented.

6.5.3 Current harmonics

6.5.3.1 Information

NORWAY AND SWEDEN:

These requirements are not a part of EN 50 388: 2005, but due to the high harmonic content in the Norwegian and the Swedish network, which in turn causes high peak value in the line voltage (see section 6.1.3, Harmonics), these requirements are needed in order not to worsen the situation.

6.5.3.2 Requirements

NORWAY AND SWEDEN:

The current harmonics generated by the vehicle are not allowed to exceed the levels in the following table. The individual harmonics are related to the rated current of the vehicle.

Table 6-2: Limits for individual current harmonics

Harmonics	3	5	7	9
Current level, % of I_N	5	3	3	3

THD_I shall not exceed 8% (0.08), where

$$THD_I = \frac{\sqrt{I_2^2 + I_3^2 + \dots + I_n^2}}{I_N}$$

I_N = rated current for the vehicle (fundamental, 16 2/3 Hz).

n = Varying harmonics, n = 2, 3, 4 ...

Even harmonics are implicitly limited by the THD_I –value.

Individual inter-harmonics in the current shall not exceed more than 3% of the fundamental rated current.

The limits presented above for current harmonics are under investigation and shall be considered as target values. The limits represent the 95%-percentile of the measured line current harmonics.

6.5.3.3 Verification

NORWAY AND SWEDEN:

Verification of the requirement shall be made by test measurements. Tests are specified in chapter 7, Validation and tests, section 7.3, Tests regarding compatibility with the power supply.

6.5.3.4 Documentation

NORWAY AND SWEDEN:

The results of the tests shall be presented in a technical report.

6.6 Relay protection and coordination

6.6.1.1 Information

NORWAY AND SWEDEN:

All current values in this clause refer to the sub-transient short circuit currents.

The highest short circuit current in the railway power supply system is 25 kA.

NORWAY:

Feeding stations and switching posts are normally equipped with the following relay protection:

- Distance protection as normal primary protection at branches:
 - Zone 1 covers normally 60-85% of line and have a disconnect time less than 0.15 s
 - Zone 2 covers the whole line and usually 20-25 % of adjacent lines with disconnect time usually less than 0.3 s. Zone 2 is triggered by a current step of 200 A or a voltage step of 2 kV during 0.2 s.
- Over current protection as normal secondary protection at branches equipped with distance relay protection, and as primary protection at branches without distance protection (often switching yards, railway stations, weak feeding stations and so on). Time for disconnection is based on normal load current, short circuit current, thermal capacity of line and (if applicable) the setting in distance protection, but the highest instant disconnection time is set to be no longer than 0.1 s
- Under voltage protection of branches, usually triggered by voltages less than 10 kV in 2.0 s, and protection of busbar, usually triggered by voltages less than 9 kV in 0.5 s.
- Thermal protection of the overhead contact wire at some high loaded branches/lines.
- Testing resistor (640 Ohm) at most branches
 - Before a line/branch is activated, the voltage is applied via the testing resistor in order to detect faults or short circuits. If the line impedance is sufficiently high, the branch circuit breaker will be switched on.
- Fast over current protection at some branches.
- Automatic circuit breaker re-closing at most branches, if the circuit breaker has tripped due to distance, over current, 100 Hz and under voltage protection. Re-closing is executed 5 s after the breaker has tripped first time, and then 30 s and 180 s, respectively, after the previous re-closing attempt has ended.

- In general, the 100 Hz protection in the static converter stations orders disconnection if the current harmonics around 100 Hz exceed given levels.

Coupling posts are equipped with the following relay protection:

- Under voltage protection disconnecting if the voltage is below approx. 6 kV for more than 20 s.
- Under voltage and over current protection disconnecting if the voltage is below approx. 10 kV and the current is above 300 A for 0.4 s.

SWEDEN:

The relay protection for the lines and the busbar at converter stations and switching posts is normally of the following types:

Protection of the 15 kV lines:

- High speed over current protection (< 50 ms for static and < 10 ms for numerical relays): Normal setting for the current is 1500-2000 A.
- Two-step distance protections in combination with a current/voltage jump relay. The second step is activated by the current/voltage jump relay, set at 175 - 450 A and 2 kV. The first step covers 65 - 85% of the line, step two covers 100 % of the first line and from 30 % up to 50 % of the next line.
- Time over current protection with an approximate setting of: 800-1200 A, delay time 1-3 s (inverse or constant).
- Thermal protection against prolonged overloading of the contact line.
- Normally each line has a test resistor of 640 Ω . Before the circuit breaker for a line is closed, a voltage is applied to the line via this test resistor, and if the impedance is sufficiently high the circuit breaker closes.
- Automatic circuit breaker re-closing exists on most lines, operating if the circuit breaker has tripped due to distance or over current protection. Re-closing is executed 5 s after the breaker has tripped the first time, and then again 60 s after the previous re-closing attempt has failed and is terminated. If the last attempt fails, the breaker is blocked and must manually be closed from the dispatch centre.

Protection of the 15 kV busbar:

- Undervoltage protection with a normal setting of 9 kV, 0.5 s.

The disconnection time for a fault with a high current (> 1500 A) is less than 150 ms.

6.6.1.2 Requirements

NORWAY AND SWEDEN:

Requirements are in accordance with EN 50 388:2005, clause 11.

Note that in case the breaker capacity is higher than the highest short circuit current in the power supply system, the breaker shall open immediately for all faults in the vehicle. When applying this rule, it must be considered if the vehicle is also operating in other countries

where higher short circuit currents may occur. In that case the breaker shall be staged for faults on the primary side of the transformer.

6.6.1.3 Verification

NORWAY AND SWEDEN:

Functional description.

6.6.1.4 Documentation

NORWAY AND SWEDEN:

Technical report and conformity statement.

6.7 AC inrush currents

6.7.1.1 Information

NOTE: This is not the same requirement and test that is specified for DC inrush current for Sweden in section 5.2, Track signalling circuits, sub-section 5.2.1.3. The DC inrush current requirement is only of interest in Sweden due to the DC track signalling circuits, whereas the AC inrush current requirements and tests are of interest in both countries due to the relay protection.

NORWAY AND SWEDEN:

One of the relay protection systems commonly used in both in Norway and Sweden is over current relays at different speed as (see chapter 6.6). These over current protections limit the allowed AC inrush currents from a vehicle when connecting (closure of breaker) it to a 15 kV line.

6.7.1.2 Requirements

NORWAY AND SWEDEN:

Maximum magnitude of the inrush current from the transformer or any other equipment in the vehicle shall not exceed 2000 A (peak-value) during the two first periods, 120 ms, after breaker closure. This value is valid when connecting the vehicle to a rigid 16.5 kV, 16.7 Hz. The requirements are valid for a complete traction unit which can be more than one vehicle.

When several vehicles are connected (multiple unit operation) to the 15 kV system, it is desired that breaker operations on the vehicles are unsynchronized, i.e. that there are different delays imposed on each vehicle.

6.7.1.3 Verification

NORWAY AND SWEDEN:

Verification shall be made by calculations and tests. The tests are specified in chapter 7, Validation and tests, section 7.3, Tests regarding compatibility with the power supply.

6.7.1.4 Documentation

NORWAY AND SWEDEN:

Technical report with test results.

6.8 Regenerative braking

6.8.1.1 Information

NORWAY AND SWEDEN:

Normally, most of the regenerative power from rolling stock will be consumed by other trains. Temporary sectioning of the network may to a large extent reduce, or completely disable, the single-phase network's ability to absorb regenerative power feedback.

Regenerative power feedback may in some sections be limited even further than mentioned below, due to special reasons.

All rotary converters and some static converters can feed power back to the 3-phase network. Some static converter stations can not receive power feedback from the single-phase network at all. In these stations the energy may be "pushed" forward by shifting the phase angle of the output voltage.

NORWAY:

Due to the contact line's thermal capacity, and in order to enable the protection for outgoing lines to detect a short circuit while at the same time rolling stock feeds back regenerative power, the power supply is divided into the following classes of allowable regenerative feedback:

- Class B1: Regenerated power limited to corresponding maximal train current (I_{\max} in section 6.4.1 Maximum current limitation)
- Class B2: Maximum 10 MW regenerated power per train
- Class B3: Maximum 8 MW regenerated power per train
- Class B4: Maximum 5 MW regenerated power per train (usual classification in Norway)

Note the limits in section 6.3 Power factor and 6.4.1 Maximum current limitation.

Norwegian infrastructure is not equipped for automatic power selection.

The Norwegian National Rail Administration may, after consideration, remove the restrictions on sections of the network in response to specific requests for traffic or use of rolling stock. Class B4 is a minimum classification for a whole line and is expected to cover more or less all practical operational cases for today and the near future.

6.8.1.2 Requirements

NORWAY AND SWEDEN:

Requirements for regenerative braking in EN 50 388:2005, clause 12 must be fulfilled. Furthermore, it is not allowed to regenerate power to a neutral section. Feedback of regenerative braking power should be brought to zero when entering such a section.

Vehicles must not continue to feed back power if the requirements for maximum voltage limit given in section 6.1.1 in this document are exceeded, but there is no requirement for the durations of unspecified period described in EN 50 163:2004, table 1, subsection f) given for regenerative power feedback.

NORWAY:

A train must not feed back more regenerative power than the limit for the section on which the train is currently operating.

Power feedback limiting must be done manually by a current selector. If a system, which automatically stops power feedback from the train when a short circuit occurs in the actual section, can be documented to have adequate performance, then the restrictions due to the protection's ability to detect short circuits can be lifted.

6.8.1.3 Verification

NORWAY AND SWEDEN:

Testing of regenerative braking must be carried out in accordance with EN 50 388:2005, section 13 and 14.

Verification that the vehicle does not regenerate power to a neutral section or to a contact line that is disconnected from the power supply system, or to a short circuit, shall be based on conformity statements and functional descriptions. No practical tests on sites in Norway and Sweden are required.

Verification of the voltage limiting function shall be made by test measurements. The tests are specified in chapter 7, Validation and tests, section 7.3, Tests regarding compatibility with the power supply.

6.8.1.4 Documentation

NORWAY AND SWEDEN:

Tests shall be documented in test reports with diagrams presenting the results.

Functional descriptions must be presented, showing how the vehicle/s act when entering a neutral section or when a short circuit occurs, both close to the vehicle and at a far distance.

NORWAY:

Arrangements and procedures for limiting the maximum power feedback in accordance with the given information must be documented.

6.9 Other special requirements

6.9.1 Train pre-heating systems

6.9.1.1 Information

NORWAY:

The Norwegian National Rail Administration offers three different systems for connecting rolling stock to stationary pre-heating facilities. For more information about the systems and geographic location of connection points see Network Statement, item 5.3.3.1.

The following systems exist in Norway (but with different and limited extension):

1000 V, 50 Hz

1000 V, 16.7 Hz (most common)

3 x 400 V, 50 Hz (up till now only on non-electrified lines)

Maximum power output per pre-heat post:

For 1000 V post: 100 - 630 A (large variations, local limits are described in the Network statement).

For 400 V post: 63 A.

SWEDEN:

The following system exists in Sweden:

1000 V, 16.7 Hz

6.9.1.2 Requirements

The train pre-heating systems must meet all of the following requirements.

For all systems the following apply: Automatic or technical interlocking devices in the train, or manual operating routines are required in order to prevent interconnecting the power supply from stationary pre-heat posts, other potential external power supplies, or supply through the train pantograph.

NORWAY:

For 1000 V systems the connection plug must be designed in accordance with UIC 552.

For 400 V systems the contact type must be a circular pin plug 436-6 with pilot contact (L1-L2-L3-N-PE-pilot). Connections in accordance with UIC 554-1, plate IV.

SWEDEN:

The design of the connection to the pre-heating installation must be designed in accordance with UIC 550 and UIC 552.

NORWAY AND SWEDEN:

To ensure selectivity, the first peak of the inrush current, when connecting the vehicle to a pre-heating installation, must not exceed 2000 A (peak) at 1000V, 16.7 Hz.

6.9.1.3 Verification

NORWAY AND SWEDEN:

Verifications shall be made by technical and functional descriptions.

Verifications shall also be made by tests. The tests are specified in chapter 7, Validation and tests, section 7.3, Tests regarding compatibility with the power supply.

6.9.1.4 Documentation

NORWAY AND SWEDEN:

A technical report, which shall include the test results.

6.9.2 Energy measurements

6.9.2.1 Information

NORWAY AND SWEDEN:

Both Norwegian and Swedish National Rail Administration are members of Nordic Railway Energy Settlement System (NRESS). This system allows automatic transfer of data such as time and date, energy demand and GPS-position from the train energy measurement system.

6.9.2.2 Requirements

NORWAY AND SWEDEN:

Energy measurement system onboard in train shall have a total uncertainty of max. 1.5 %. For older rolling stock that had the current and/or voltage transformer installed since before 2007-01-01, a total uncertainty of max. 5 % may be accepted.

The energy meter shall be accepted by either the Norwegian or the Swedish National Rail Administration.

NORWAY:

Rolling stock operating in Norway may be equipped with energy meters as described in this section. Otherwise energy invoicing will be based on key figures and reported/estimated gross ton kilometre driven.

SWEDEN:

New and old rolling stock, not operating in Sweden before, shall be equipped with energy meters as described in this section.

6.9.2.3 Verification

NORWAY AND SWEDEN:

Total system uncertainty shall be calculated in accordance with calculation method given in Guide to Expression of Uncertainty in Measurement (GUM) by International Bureau of Weights and Measures (BIPM). The calculations shall be based on square distribution and a coverage factor of 2.

6.9.2.4 Documentation

NORWAY AND SWEDEN:

Total system uncertainty shall be documented.

6.9.3 Outside antennas on vehicles

6.9.3.1 Information

NORWAY AND SWEDEN:

Requirements in this document consider outside antennas for railway vehicles.

6.9.3.2 Requirements

NORWAY AND SWEDEN:

Antennas for railway vehicles shall satisfy the requirements on touch voltage in accordance with EN 50 122-1 Railway applications- Fixed installations Part 1: Protective provisions relating to electrical safety and earthing and EN 50 155 Railway applications Electronic equipment used on rolling stock.

SWEDEN:

Antennas for railway vehicles shall satisfy the requirements in Swedish National Rail Administration's document BVS 545.43501 Krav på yttre antenner för järnvägsfordon. (Requirements on external antennas for railway vehicles).

6.9.3.3 Verification

NORWAY:

According to relevant standards, EN 50 122-1 and EN 50 155.

SWEDEN:

According to BVS 545.43501 Requirements on external antennas for railway vehicles. Clause 4.1- 4.6. The tests should be performed as a factory type test.

6.9.3.4 Documentation

NORWAY AND SWEDEN:

A conformity statement.

6.9.4 Other electrical equipment

6.9.4.1 Information

NORWAY:

No specific information.

SWEDEN:

This can also refer to heating of driver cabins in some cases, but not whole trains.

6.9.4.2 Requirements

NORWAY:

No specific requirements.

SWEDEN:

If vehicles have equipment that demands 400/230 V, 50 or 16,7 Hz power supply from local main supply or auxiliary systems the installation must be in accordance with UIC 554 in applicable parts. Note that these types of connections are very rare in Sweden and exist foremost on non-electrified lines.

6.9.4.3 Verification

NORWAY:

No specific verification.

SWEDEN:

Technical description.

6.9.4.4 Documentation

NORWAY:

No specific documentation.

SWEDEN:

Technical report.

6.9.4.5 Documentation

No documentation needed except from the requested data and figures.

7 VALIDATION AND TESTS

7.1 Pre-requirements

Before test runs and/or demonstrations are allowed on the railway lines in Norway or Sweden, some documentation is required. In addition to the documentation mentioned later in this chapter, which refers to electrical requirements and how to perform tests, there are some other pre-requirements to be met. These pre-requirements and documentation concern topics like:

- train control (ATC)
- profile
- running behaviour
- axle loads, etc.

These pre-requirements are not covered in this document and it is the responsibility of the applicant for the acceptance to contact the authority in the country in question to get the complete information regarding these requirements.

(Note: it is possible to test or demonstrate a vehicle without ATC by connecting the vehicle under test to an accepted vehicle. Special provisions must however be made so that correct test conditions are met, i.e. the accepted extra vehicle must not influence the test results.)

7.1.1 Current components which can effect signalling circuits and telecommunications

Documentation which contains estimations or calculations of current components that can be harmful for the track signalling circuits is required. This applies also for the psophometric current. Instead of this documentation or pre-requirements, these entities can be tested on a closed track before any other tests are performed. See also the requirements in section 5.2, Track signalling circuits, and 5.4, Telecommunication disturbances and psophometric currents.

7.1.2 Radiated EMC

EMC test regarding radiated emission shall be performed by the manufacturer (or applicant) at the factory before any tests on railway lines in Norway or Sweden. See section 5.3, Radiated interference.

7.1.3 Simulations of dynamic vehicle behaviour

Testing of new vehicles on the railway infrastructure is very costly and shall be kept to a minimum for the benefit of all involved parties in long term. In order to reduce the risk of a failure of some tests as well as to document vehicle characteristics which can not be tested directly, simulations shall be performed by the vehicle manufacturer.

It is recommended that the simulation results are presented to and discussed with the Norwegian and/or the Swedish National Rail Administrations prior to the first tests with the new vehicle.

This concerns low frequency power oscillations (see 6.5.1) and electrical resonance stability (see 6.5.2) and is based on EN 50388:2005, clause 10, steps 1 to 11 of the compatibility study.

7.1.4 Current or power control at low voltage

Documentation of current limitation as function of voltage is required.

7.1.5 Regenerative braking

Documentation of the voltage limitation function when using regenerative brake is required.

7.1.6 Test plan

A test plan shall be presented to the accepting authority before any measurements or tests are carried out. The test plan shall contain a description on how the tests are performed (i.e. what lines shall be used, closed track or mixed traffic and so on) and on the vehicle constellation (load, weight and so on). Furthermore, the test plan shall include a description of the instrumentation and measurement methods that will be used and how the instrumentation is calibrated. This information shall also be included in the test reports.

7.2 Tests regarding safety, safety systems and third party

Tests of the requirements in chapter 5, Specific Requirements regarding safety, safety systems and third party, are a bit more special and can normally not be combined with other tests and hence are specified under each requirement respectively. During these tests the vehicle under test is not to be driven back and forth on the specified tests site as for the power supply compatibility tests, see 7.3 below, but rather with trials along a line, except for standing still tests. Also the test cycles differ.

7.3 Tests regarding compatibility with the power supply

All tests shall be performed with one vehicle alone and with the maximum configuration of vehicles (i.e. multiple units) for which the approval must be valid. In the case of locomotives, tests must be performed both at light load (a few wagons or one or two deactivated locomotives coupled to the unit under test) and at heavy load (with a real train or braking locomotives as load).

Almost all tests below shall be carried out by means of test runs or trials. Each test run or trial shall include the following cycles:

- Acceleration from standstill to max speed (given by train or infrastructure) with maximum tractive effort.
- Running at max speed in 10 to 20 seconds
- Braking to max speed minus approximately 40 km/h with maximum electric braking effort
- Maximum acceleration back to max speed
- Braking with maximum electric braking effort to standstill.

The trials are normally to be performed on a test site by driving back and forth. At least 5 trials per test condition shall be performed. These types of trials shall be performed on both closed track and in mixed traffic, depending on the test in question.

The test program must also include Mixed Traffic Tests, by running in normal operation in areas with heavy traffic as well as low traffic. For Norway and Sweden these trips shall be performed on lines which are fed from rotary as well as static converters. For Sweden these trips shall also include driving on lines fed by the 132 kV system.

The exceptions from the trial tests specified above are Outside antennas on vehicles, section 6.9.3, AC inrush current verification tests, section 7.3.7 and Train heating systems verification tests, section 7.3.9. These tests are specified in chapter 6 or below. It can be discussed whether the test cycle above can be used for measurements of the psophometric current, see section 5.4, or not, but please note that measurements of the psophometric current shall be made while performing tests cycles when driving from one converter station to another along a line in closed traffic.

The speed range should cover both constant torque and constant power drive, according to the tractive effort curve, when these are included in the speed range for which the approval must be valid.

The different tests are summarized in table 7-1 below.

The following sections detail the tests that are required in order to demonstrate compliance with the requirements in chapter 6, Requirements regarding compatibility with the power supply and other issues. Some requirements do not require a test as verification, only conformity statements and/or technical functional descriptions. These requirements are omitted in the following sections and in table 7-1. Also omitted are the test regarding Outside antennas on vehicles, these test are referred to in section 6.9.3.

Also the test of signalling equipment interference and psophometric currents are included in the table.

Table 7-1. Test summary

Validation tests (requirements)	Operating conditions										
	Closed track (no other traffic)					Mixed traffic					
	Rotating converters	Static converters	132 kV feeding ¹⁾	Rotating converters	Static converters	132 kV feeding	Rotating converters	Static converters	132 kV feeding	132 kV feeding	
	Close to sub-station (strong line)	Far from sub-station (weak line)	Far from sub-station (strong line)	Close to sub-station (strong line)	Far from sub-station (weak line)	Close to sub-station (strong line)	Far from sub-station (weak line)	Close to sub-station (strong line)	Far from sub-station (weak line)	Close to sub-station (strong line)	Far from sub-station (weak line)
5.2 Signalling system ... NORWAY (Req. 5.2)	X ^{2,3)}	(X) ^{2,3)}									
5.2 Signalling system ... SWEDEN (Req. 5.2)	These tests shall be made when the train/vehicle is standing still beyond the first booster transformer and at a place where I _k > 20 kA										
5.4 Telecommunication disturbances (Req. 5.4)	X ^{2,3)}	(X) ^{2,3)}									
7.2.1 Voltage level withstand tests (Req. 6.1.1)					X ⁴⁾		X ⁴⁾		X ⁴⁾		X ⁴⁾
7.2.2 Harmonics withstand tests (Req. 6.1.3)					X ⁴⁾		X ⁴⁾		X ⁴⁾		X ⁴⁾
7.2.3 Power factor tests (Req. 6.3)	(Z) ^{5,6)}	(W) ^{5,6)}	(Z) ^{5,6)}	(W) ^{5,6)}			X ^{4,5)}	X ^{4,5)}	X ^{4,5)}	X ^{4,5)}	X ^{4,5)}
7.2.4 Max current limitation tests (Req. 6.4.1)	(X) ⁶⁾		(X) ⁶⁾								
7.2.5 Current or power control, low voltage (Req. 6.4.2)		(X) ⁶⁾		(X) ⁶⁾							
7.2.6.1 Low frequency power osc. (Req. 6.5.1)	X ^{7,8,10)}	X ^{7,9,10)}	X ^{7,8,10)}	X ^{7,9,10)}		Z ^{1,7)}					
7.2.6.3 Current harmonics (Req. 6.5.3)	X ²⁾	(X) ²⁾		(X) ²⁾							
7.2.7 AC inrush current tests (Req. 6.7)	These tests shall be made when the train/vehicle is standing still at a place where the short circuit current, I _k , is greater than 20 kA										
7.2.8 Regenerative braking tests (Req. 6.8)	(X) ⁶⁾			(X) ⁶⁾							
7.2.9 Train heating tests (Req. 6.9.1)	These tests shall be made when the train/vehicle is connected to a heating post										

Note 1: 132 kV feeding is only applicable for Sweden.

Note 2: When one or more symbols of the same kind are within parenthesis but one is not, the site which is without parenthesis is preferred but the other one/s can be discussed.

Note 3: These tests are to be performed with trials driving along a line.

Note 4: All sites crossed under "Mixed traffic" means trials including normal trips in areas with heavy traffic and with different types of feedings, both strong and weak, but weak are the most important.

Note 5: When more than one symbol, i.e. x, z and w, are specified, tests for each symbol must be carried out.

Note 6: When two or more symbols of the same kind are within parenthesis one of the sites can be chosen.

Note 7: Tests of low frequency oscillations shall be performed with good and bad adhesion

Note 8: When testing low frequency oscillations close to a converter station the installed power shall be as low as possible, i.e. in the same ranges as the rated power of the vehicle.

Note 9: Tests of low frequency oscillation on weak lines shall be made with both low and high installed power. High installed power can be tested with either rotary or static converter station.

Note 10: Tests of low frequency oscillations in Norway shall include measurements in the feeding converter station.

7.3.1 Voltage levels verification tests

These tests refer to requirement regarding Line Voltage, clause 6.1, and sub-section 6.1.1, Levels.

The ability of the rolling stock to operate at the specified voltage levels must be tested in accordance with EN 50 215:1999, clause 9.15. The tests can not be replaced by tests on the inverter only (EN 50 207:2000) as stated in EN 50 215:1999, clause 9.15.

Voltage level testing must be carried out in an area that is representative with respect to the future operation, and the tests must include all relevant operating conditions such as acceleration, retardation, activation of wheel slip and slide protection, and regenerative braking. The tests shall include trials as specified above as well as normal driving in areas with other traffic, preferably with many phase controlled vehicles. During the tests, the RMS level of the voltage as well as the fundamental and harmonic levels shall be recorded. Peak voltage values (instantaneous peak values), RMS-values, as well as the fundamental and harmonic levels shall be presented after the tests, preferably in the form of cumulative distributions for the different values.

Tests of voltage jumps shall be performed on a weak double end fed line where one of the feedings shall be switched on and off when the vehicle is fairly close to that station.

Practical short circuit tests on a line as described in EN 50 215:1999, clause 9.15.4 shall not be performed. These tests are to be performed as factory tests instead.

The tests can be combined with the tests described in section 7.3.2 and partly with tests specified in section 7.3.3.

7.3.2 Harmonics withstand verification tests

These tests refer to requirement regarding Line Voltage, clause 6.1, and sub-section 6.1.3, Harmonics.

The test shall be performed according to the tests specified in section 7.3.1.

NOTE: A suitable area in Sweden could be around Borlänge and Avesta –Krylbo, where high crest factors have been measured.

7.3.3 Power factor verification tests

These tests refer to requirement regarding Power factor, clause 6.3.

The requirements shall be verified by calculations, using measured power factors at different operating conditions, in accordance with EN 50 388:2005, clause 6, 13 and 14. As an alternative the verification can be made by measurements and the use of Figure 6-2.

Measurements of power factor (U and I with phase angles for the fundamentals) at the pantograph shall be performed during the tests specified in section 7.3.1 and 7.3.2. Furthermore, measurements shall be performed during trials close to a converter station

(strong line) and far away from converter station on a single fed line (weak line). The tests close to a converter station can be combined with the tests of maximum current limitation, section 7.3.4, or current harmonics, section 7.3.6.3. The test far away from a converter station can be combined with tests of regenerative braking, section 7.3.8.

7.3.4 Maximum current limitation verification tests

These tests refer to requirement regarding Current limitation, clause 6.4, and sub-section 6.4.1, Maximum current limitation.

Tests and measurements of drawn and regenerated current shall be made on a strong line. Both current, voltage and phase angle shall be measured and presented after the tests. Notice that the regenerated current during braking is of particular interest in Norway.

The tests can be combined with parts power factor verification tests, section 7.3.3, and current harmonic measurements, section 7.3.6.3.

7.3.5 Current or power control at low voltage verification tests

These tests refer to requirement regarding Current limitation, clause 6.4, and sub-section 6.4.2, Current or power control at low voltage.

Tests shall be made on a weak single fed line by measuring the voltage and current. The tests can be combined with the test of regenerative braking, section 7.3.8, and partly with the tests of power factor, section 7.3.3.

7.3.6 Harmonics and dynamic effects validation tests

7.3.6.1 Low frequency power oscillations

The verification shall be done by testing under typical operational as well as one or several worst case situations. These situations shall be as similar as possible to those investigated in the simulation study. A test plan according to EN 50388:2005, clause 10, step 12, is required before starting the tests.

NORWAY AND SWEDEN:

Testing shall be done with maximum number of vehicles for the following conditions:

- Close to a substation with low power rating equipped with a rotary converter (<15 km)
- Close to a substation with low power rating equipped with a static converter (<15 km)
- Far from a substation equipped with a rotary converter with low power rating (> 55 km, high line impedance)
- Far from a substation equipped with a static converter with low power rating (> 55 km, high line impedance)
- Far from a powerful substation equipped with a static or rotary converters (> 55 km, high line impedance, but high installed substation power)

When low power rating is specified, lowest rated power of substation converters possible shall be used. That implies converter capacity approximately in same range as train power.

Furthermore, a sectioned single line network should be used (no connection of test section and test converter to the rest of the network).

For Sweden also one test with feeding from the 132 kV system is desired. This can be combined with the last item in the list: “Far from a powerful substation...”.

The test trials shall be according to the description in section 7.3 above. Both good and bad rail-to-wheel conditions have to be tested. This means that each test sequence shall be repeated five times with good adhesion and five times with bad adhesion.

Furthermore, tests shall be made with voltage jumps. These tests can be combined with voltage jump tests described in section 7.3.1. The tests far from substations can be combined with the tests for current limitation, section 7.3.5, and tests of regenerative braking, section 7.3.8.

Recordings as function of time on the train have to include:

- Speed
- Line voltage
- Line current (this is the only signal which will allow a synchronisation with measurements done by the infrastructure owner in the substation)
- Line power (both active and reactive), calculated with the methods described in section 7.4.3 below.

Experiences have shown that the low frequency oscillations have more consequences and are easier to bring about in Norway than in Sweden; therefore the Gjøvik-line north of Oslo is recommended as test site for rotary converters (single line feeding and not very dense traffic).

NORWAY:

In addition to measurements on vehicle, measurements in the feeding converter station are also required. Activities in the converter station must be carried out according to Norwegian National Rail Administration's instructions.

Recordings as function of time in converter stations have to include:

- Active power at converter unit single-phase side and three-phase side
- Line current on single-phase side (this is the only signal which will allow a synchronisation with measurements done in the train)

7.3.6.2 Electrical resonance stability

No specific tests are required except that the voltage shall be recorded during all mixed traffic tests, and that the recorded voltage shall be analyzed with respect to harmonics. Specific test methods are under investigation.

7.3.6.3 Current harmonics

These tests refer to requirements regarding Harmonics and dynamic effects, clause 6.5, and sub-section 6.5.3, Current harmonics.

To verify the fulfilment of these requirements, the current shall be measured when the vehicle is close to a converter station with rotary converters. As an alternative, a converter station equipped with modern static converters of type MegaMacs, or another modern type of static converter which produce a low amount of harmonics can be discussed. Trials shall be made as described in section 7.3 above.

7.3.7 AC inrush current verification tests

These tests refer to requirement regarding AC inrush currents, clause 6.7.

NOTE: this is not the same test that is specified for DC inrush current for Sweden in section 5.2, Track signalling circuits, sub-section 5.2.1.3.

Note that these tests differs from the tests and normal trial described in section 7.3 above.

Verification shall be made by calculations and tests. The test shall constitute at least 10 trials of breaker closures if it is possible to synchronize the closure to a voltage zero crossing. If it is not possible to synchronize to voltage zero crossings at least 20 trials of breaker closures shall be performed.

The tests shall be performed at a location where the short circuit current is greater than 20 kA, i.e. $I_k > 20 \text{ kA}$.

(In Sweden this means tests directly outside Häggvik converter station with 4 rotary converters running and an additional connection to the 132 kV system, or 5 rotary converters running and with the 132 kV system disconnected. In Norway this means tests directly outside the converters at Oslo S with all converters running.)

The current shall be recorded and the whole course of the inrush current (instantaneous values) for each trial shall be presented after the tests.

7.3.8 Regenerative braking verification tests

These tests refer to requirement regarding Regenerative braking, clause 6.8.

Testing of regenerative braking must be carried out in accordance with EN 50 388:2005, section 13 and 14.

Validation that the vehicle does not regenerate power into a neutral section, into a contact line that is disconnected from the power supply system, or into a short circuit, shall be by means of conformity statements and functional descriptions. No practical tests on sites in Norway and Sweden are required.

Verification of the voltage limiting function shall be made by measurements on a weak single fed line where the vehicle shall regenerate at full power. Trials as described in section 7.3 above shall be used, where the part with full regenerative braking power is of interest for these tests.

During the tests power, power factor, current, voltage and speed on the vehicle shall be measured.

7.3.9 Train heating systems verification tests

These tests refer to requirement regarding Other special requirements, clause 6.9, and sub-section 6.9.1, Train pre-heating systems.

Verifications shall be made by tests of at least 20 trials of inrush current tests, apart from the description mentioned in clause 6.9.1, when the vehicle is connected to a heating post. No specific test-site is specified.

The current shall be recorded and the whole course of the inrush current (instantaneous values) for each trial shall be presented after the tests.

7.4 Measurement instrumentation and methods

The verification of the requirements shall primarily be made by measurements, if not stated otherwise.

7.4.1 Measurements - radiated entities

Measurements procedures and instrumentation are in accordance with EN 50 121, part 2 and 3-1.

7.4.2 Measurement instrumentation – conducted entities

All measurements shall be performed with adequate voltage and current transducers (transformers and/or active transducers such as Rogowski coils and Hall transducers. Hall transducers are particularly required for DC measurements).

Sampling instruments as in figure 7-1 are recommended. It is requested that adequate anti-aliasing filters are used. The cut-off frequency of the anti-alias filter for the current measurement must be higher than the highest frequency of interest, i.e., higher than 17 kHz for Norway (FTGS track circuits) and higher than 5 kHz for Sweden (psophometric currents). The sampling frequency must be well above two times these values.

It is recommended that all raw data be streamed directly to a storage device (DAT recorder, hard-disk, or similar) for later post-processing and analysis, in addition to the on-line supervision.

The figure below shows an example of the recommended principle of data recording and analysis, and how to install Hall transducers to measure the DC-current.

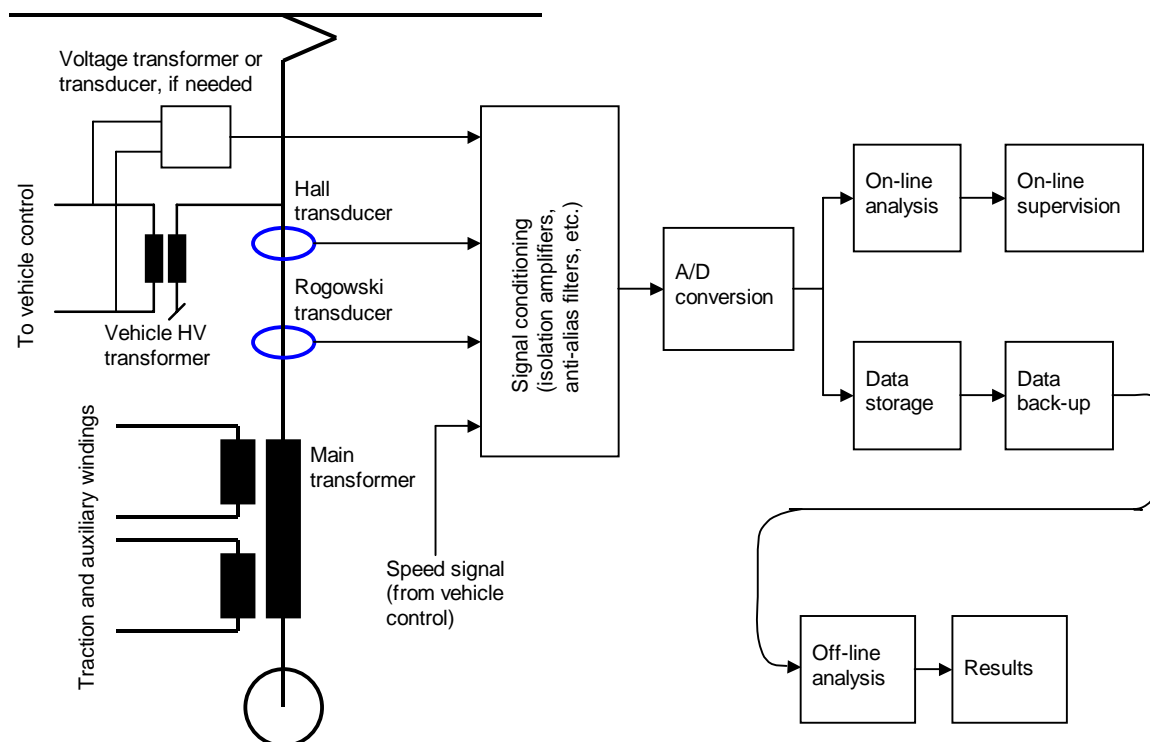

Figure 7-1 Transducer position and recommended measuring equipment.

The tolerance of the overall signal chain including transducers, signal conditioners, A/D converters, and data analysis, must be determined before the tests. A measurement error of less than $\pm 1\%$ at the fundamental, and less than $\pm 5\%$ of any of the stated interference requirements, is expected.

The principles of the data analysis, as well as the tolerances, must be described and presented before the tests, as a part of the test plan for the accepting authority.

7.4.3 Measurement methods/analysis – conducted entities

For all measurements with sampling instruments, as recommended in section 7.4.2, it is requested that adequate anti-aliasing filters are used. The cut-off frequency of the anti-alias filter for the measurement must be higher than the highest frequency of interest and the sampling frequency must be more than twice the cut-off frequency of the anti-aliasing filter. For FFT analysis, Hanning windows are preferred.

Measurements of high frequency phenomena, such as for the Norwegian signalling circuit interference, a sampling frequency of approximately 50 kHz is recommended together with an anti-aliasing filter with a cut of frequency of 20 kHz. For the signal processing see chapter 5.2

For measurements of psophometric currents, the corresponding frequencies are 12 kHz and 5.5 kHz, i.e. a sampling frequency of at least 12 kHz and a cut-off frequency for the anti-aliasing filter of at least 5.5 kHz. If FFT methods are used, the psophometric weighting

function according to ITU-T (see Appendix 9) shall be applied on the FFT bins according to the formula in section 5.4.1.1. For FFT bins between the frequencies for which the weighting factors are specified, interpolated values shall be used. The recommended window length is 480 ms. At least 50% overlapping is recommended. The applicant shall describe how he deals with spectral leakage, e.g., by adjusting the calculated levels accordingly.¹

If a digital band-pass filter is used, it must be documented that the gain of the filter is higher than the psophometric weighting function -0.1 dB throughout the frequency band 50 Hz – 5 kHz. The recommended RMS integration time is 480 ms.

(As an alternative to the recommended set-up and procedure for psophometric current measurements a psophometer according to ITU-T Recommendation O.41, October 1994, may be used.)

For measurements of frequencies from the fundamental and harmonics up to about 1 kHz, the instrumentation shall produce T_W -values, i.e. window values, as defined in EN 61000-4-7:1993, clause 8. The window length shall be in accordance with quasi-stationary harmonics, the recommended window width is 480 ms (8 x 60 ms) for 16.7 Hz power supply and 160 ms (8 x 20 ms) for 50 Hz power supply. The windows can be shorter. Gaps of one period of the fundamental between windows are allowed, but not preferred. It is recommended that overlapping windows are used. For weighting of sampled data Hanning-window is preferred. T_{VS} -values, i.e. 3-second values, can be discussed for some tests, but T_W -values are preferred.

Note that EN 61000-4-7:1993 is specified for 50 Hz networks but is also applicable for 16.7 Hz-networks using a time window of 8 periods, 480 ms, or shorter, and using a sample frequency of at least 2.5 kHz, but preferably higher. If higher sampling frequencies are used the instrumentation can be used to measure frequencies that comprise the switching frequency of the converter on the vehicle.

The recommendations and requirements on the measurement above assume that the current and voltage are measured and recorded, and that $\cos(\varphi)$ is calculated from these entities. It must be possible to distinguish between capacitive and inductive $\cos(\varphi)$.

Low frequency phenomena, i.e. DC-components, inrush currents and so on, may be measured using a sampling frequency of minimum 1 kHz (0.4 kHz anti-aliasing filter or similar).

For low frequency stability phenomena, the quantities voltage, current and power must be presented. For evaluation of low frequency components in the power signal, one of the two following procedures is recommended. They both assume that the data has been recorded.

¹ Note that with a window length of 480 ms the frequency distance between FFT bins will be $\Delta f = 2.08333$ Hz. This means that even small variations in the fundamental frequency will cause higher harmonics to end up in an adjacent bin to the one they were meant to end up in. This in turn implies that a method of only using FFT bins which corresponds to pure harmonics (throw away the rest of the bins) can give erroneous results. Even if one adjust the window length to achieve $\Delta f = 8 \frac{1}{3}$ Hz a variation of 0.05 Hz in the fundamental frequency (16.7 Hz) will cause harmonics over 2.7 kHz to end up in an adjacent bin. This could be one reason for choosing a digital filter as method instead of FFT analysis when evaluating the psophometric current. For 50 Hz system the situation is better.

The voltage and the current shall be multiplied in the time domain and the resulting power shall be filtered with a filter with a cut off frequency of about 12 Hz. After that a FFT-assessment shall be carried out using a time window of at least 2 seconds to get a maximum frequency step of 0.5 Hz. The window shall be moved so that worst case is covered, or better: use a moving time window with overlap and plot the different frequency amplitudes of the power over time. A suitable step to move the window ought to be about 0.5 second.

An alternative method is to calculate the power alteration by filter the result with a band-pass filter with the cut-off frequencies of 0.5 and 5.5 Hz (a filter of $2 \cdot 4^{\text{th}}$ order Butterworth filters is suggested). The RMS value of the power oscillations is then calculated with a moving RMS filter with 2 second integration time. If high or constant oscillations occur this can be analysed with the FFT-method mentioned above in order to find out at what frequency the oscillations occur.

Other types of measurement and evaluation methods, than the recommendations above, can be discussed, but the applicant must then show how these measurements will be carried out and what accuracy will be achieved.

8 DOCUMENTATION

8.1 General

All documentation shall be in English. The documentation shall contain:

- Technical functional descriptions, when required
- Measuring equipment
- Accuracy
- Calibration
- Test set up (trains other locos and so on)
- Software version on vehicle
- Time and date for the tests
- Track/line sections and distance from start of line for the presented registrations
- Information about number of repetitions and approximate location for the various tests. Based on this, the applicant must evaluate whether the results can be considered as typical and representative for the later use of the rolling stock, or if special conditions not included in the tests may potentially lead to future problems.
- Discussion of the results and evaluation and a conclusion whether each requirement is fulfilled or not, i.e. a confirmative statement for each requirement.
- A summary report (or a summary as a part of the whole report) where the test results are summarized with remarks and observations, especially incompatibilities and exceedances of limits.

Furthermore, a general technical description containing a principle block diagram of the traction circuits of the vehicle is required.

8.2 Input data for simulations

In order to develop traction power system for future, investigate power systems problems and do energy demand and loss calculations some key information about vehicles are needed.

The following information must be prepared and submitted to respective National Rail Administration as input to the traction power supply computer program:

- Motor type (asynchronous motor or direct-current motor)
- Dynamic mass [metric tons] of vehicle including load
- Mass [metric tons] of vehicle including load
- Adhesion mass [metric tons] of vehicle
- Maximum speed [km/h] for vehicle
- Length [m] of vehicle
- Curve resistance CR0 [kNm/tons] and CR1 [m] as function of curve radius [m] as in formula
(curve resistance)=CR0/((curve radius)-CR1)·MASS
- Minimum allowed curve radius [m] for the vehicle

- Running resistance RRA [kN], RRB [kN/(km/h)] and RRC [kN/(km/h)²] on straight track as function of speed [km/h] in formula (running resistance)=RRA+RRB·v+RRC·v²
- Adhesion coefficients ADH1 [km/h] and ADH2 [km/h] in adhesion formula (adhesion)=ADHCOEFF+ADH1/(speed+ADH2). ADHCOEFF is track dependent and in this simulations presumed to be 0.161
- Nominal voltage [kV] at current collector
- Active power consumption [MW] for auxiliary power, train heating and air condition which is taken directly from the main transformer (no load losses not included)
- Power factor at zero speed for auxiliary power, train heating and air condition which is taken directly from the main transformer
- Losses [MW] for the tractive equipment from current collector to wheel at no load, for instance the no load losses of the main transformer
- Maximum and continuous curve for tractive and electric braking effort [kN] as function of speed [km/h]
- Desired acceleration and retardation [m/s²] as function of speed [km/h]
- Maximum tractive effort [kN] at wheels at motoring and maximum electrical braking effort [kN] at wheels as function of speed [km/h]
- Maximum active power consumption and feedback [MW] at current collector as function of speed [km/h].
- Efficiency [%] for maximum tractive effort from current collector to wheel at maximum tractive effort as function of speed [km/h]. Auxiliary power not included
- Maximum power consumption and regeneration [MW] as function of contact line voltage [kV]. Power consumption for passenger coaches if vehicle is locomotive to be added.
- Maximum tractive effort [kN] as function of contact line voltage [kV]
- Main circuit schematics
- Filter configuration and component values/data including main transformer
- Admittance frequency response including control system

Additional data required for phase angle controlled (thyristor) vehicles:

- Number of converter bridges in series with one motor
- Maximum allowed voltage between the motor's terminals under the worst conditions in [%]
- First limitation for the motors; current or flux
- Power factor of the motor when the control is with fully advanced angle

Additional data required for inverter vehicles:

- Power angle alternative power factor for power consumption and regeneration as function of contact line voltage [kV]
- Active power consumption [MW] for auxiliary power, train heating and air condition which is taken from the converter bridge
- Power factor at zero speed for auxiliary power, train heating and air condition which is taken from the converter bridge

NORWAY AND SWEDEN:

Power system simulation software SIMPOW® and the additional module TRACFEED®
Simulation are used.

9 REVISION HISTORY

05-01-2007: First version, based on the NIM NES-R10 report with the same title as this document, from 27.11.2006.

NES NORDIC ELECTRIC POWER CO- OPERATION	TECHNICAL SPECIFICATION FROM THE NES GROUP	TS 02 APPENDICES PAGES: A61 DATE: 05.01.2007
---	---	---

**Requirements on rolling stock
in Norway and Sweden
regarding EMC with the
electrical infrastructure and
coordination with the power
supply and other vehicles**

APPENDICES

TABLE OF CONTENTS

A1	APPENDIX 1: INFRASTRUCTURE DATA AND RELATED INFORMATION.....	4
A1.1	MAIN DATA.....	4
A1.2	POWER GENERATION.....	5
A1.2.1	<i>Connection to public utility</i>	5
A1.2.2	<i>Power stations</i>	6
A1.2.3	<i>Rotary frequency converters</i>	6
A1.2.4	<i>Static frequency converters</i>	7
A1.3	POWER DISTRIBUTION.....	9
A1.3.1	<i>General data</i>	9
A1.3.2	<i>Transformer stations</i>	10
A1.3.3	<i>Transmission lines</i>	10
A1.3.4	<i>Cables</i>	11
A1.4	SUBSTATIONS	11
A1.4.1	<i>General data</i>	11
A1.4.2	<i>Autotransformers</i>	12
A1.4.3	<i>Passive filters and compensators</i>	13
A1.4.4	<i>Controlled filters, compensators and balancers</i>	13
A1.4.5	<i>Auxiliaries</i>	13
A1.4.6	<i>Other equipment</i>	14
A1.5	RAILWAY LINES	14
A1.5.1	<i>Longitudinal characteristics</i>	14
A1.5.2	<i>Cross connections on double-track lines</i>	14
A1.5.3	<i>Cross sections of lines</i>	15
A1.5.4	<i>Cable sections</i>	16
A1.5.5	<i>Return current arrangement</i>	16
A1.5.6	<i>Booster transformers</i>	17
A1.5.7	<i>Neutral sections/Phase gaps</i>	18
A1.5.8	<i>Interaction AC/DC railways</i>	18
A1.5.9	<i>Numerical values BT system</i>	19
A1.5.10	<i>Numerical values AT system</i>	19
A1.6	SIGNALLING EQUIPMENT.....	20
A1.6.1	<i>Track circuits</i>	20
A1.6.2	<i>Axle counters</i>	21
A1.6.3	<i>Automatic train protection (ATP) and automatic train control (ATC)</i>	21
A1.6.4	<i>Interference monitors</i>	21
A1.6.5	<i>Interference limits</i>	22
A1.6.6	<i>Data transmission and remote control systems</i>	22
A1.7	OPERATIONAL CONDITIONS	23
A1.7.1	<i>Line frequency</i>	23
A1.7.2	<i>Line voltage RMS value</i>	23
A1.7.3	<i>Line voltage spectrum</i>	25
A1.7.4	<i>Regenerative brake</i>	27
A1.7.5	<i>Power factor</i>	27
A1.7.6	<i>Earthing</i>	27
A1.7.7	<i>Traffic information/characterisation</i>	27
A1.7.8	<i>Network operation</i>	27
A1.7.9	<i>Infrastructure classes</i>	28
A1.8	EXISTING ELECTRICAL VEHICLES.....	29
A1.8.1	<i>Electrical locomotives in Norway and Sweden</i>	29
A1.8.2	<i>Electrical multiple units in Norway and Sweden</i>	30
A2	APPENDIX 2: NETWORK MAP NORWAY.....	31

A3	APPENDIX 3: NETWORK MAP SWEDEN	32
A4	APPENDIX 4: ADDITIONAL INFORMATION FOR STABILITY STUDIES	34
A4.1	LOW FREQUENCY POWER OSCILLATIONS	34
A4.1.1	<i>Background</i>	34
A4.1.2	<i>Definition of a simulation model</i>	34
A4.1.3	<i>Stability study</i>	35
A4.2	ELECTRICAL RESONANCE STABILITY	35
A4.2.1	<i>Background</i>	35
A4.2.2	<i>Definition of a simulation model</i>	36
A4.2.3	<i>Stability study</i>	37
A5	APPENDIX 5: DYNAMIC BEHAVIOUR OF ROTARY CONVERTERS.....	38
A5.1	SUMMARY	38
A5.2	EXAMPLES OF CONVERTER UNIT RESPONSE TO CHANGES IN LOAD	38
A5.2.1	<i>Introduction</i>	38
A5.2.2	<i>Definitions</i>	39
A5.2.3	<i>Frequency response</i>	39
A5.2.4	<i>Active power step response</i>	40
A5.2.5	<i>Active power ramp response</i>	42
A5.2.6	<i>Repetitive changes in active power</i>	43
A5.2.7	<i>Reactive power step response</i>	44
A5.3	VOLTAGE PHASE ANGLE VARIATION WITH LOAD	45
A5.4	TIME DOMAIN MODEL	47
A5.4.1	<i>Physical background</i>	47
A5.4.2	<i>Model structure</i>	48
A5.4.3	<i>Model parameters</i>	50
A5.4.4	<i>Line parameters</i>	51
A5.4.5	<i>Simulations with vehicles</i>	51
A5.4.6	<i>Simulation of several vehicles</i>	52
A5.4.7	<i>Validation examples</i>	53
A5.4.8	<i>Application of the model</i>	55
A5.5	PHASOR DOMAIN MODEL	56
A6	APPENDIX 6: TYPICAL CROSS SECTION OF A BOOSTER TRANSFORMER LINE IN SWEDEN	57
A7	APPENDIX 7: CROSS SECTION OF EXISTING AT-SYSTEM LINES IN SWEDEN.....	58
A8	APPENDIX 8: CROSS SECTION OF NEW STANDARD FOR AT-SYSTEMS LINES IN SWEDEN	59
A9	APPENDIX 9 : PSOPHOMETRIC WEIGHTING FACTORS ACCORDING TO ITU-T.....	60

A1 APPENDIX 1: INFRASTRUCTURE DATA AND RELATED INFORMATION

This appendix contains more detailed infrastructure data for Norway and Sweden based on requests from the ESC Infobank. The appendices also include a list of existing vehicles.

The data and values shall be regarded as information which can be changed without notice, hence the values shall not be considered as exact stipulated data. More specific information can be given by the authority in each country respectively.

Another source for information about the infrastructure and traffic may be the Network Statements.

A1.1 Main data

Data	Norway	Sweden
Owner	Norwegian National Rail Administration	Swedish National Rail Administration
Power supply system	15 kV, 16 2/3 Hz	15 kV, 16 2/3 Hz
Length of railway network	4000 km, of which 220 km double track	9882 km, of which 1734 km are double track or more (11 697 km track length)
Length of electrified railway network	2500 km, of which 220 km double track	7638 km, of which 1734 km are double track or more (9543 km track length)
Map	See appendix 2	See appendix 3
Modifications planned in future	Rebuilding of weak main lines and construction of some new lines (double track) that will increase capacity and cut travel time between existing railway destinations around Oslo	New single track lines on the east coast in the north of Sweden (Botniabanan and Haparandabanan) New city lines double track in Stockholm and Malmö Strengthening of some weak lines. Further away: High speed lines Stockholm-Mjölby and Gothenburg-Norway. Upgraded lines Stockholm-Sundsvall, Stockholm- Gothenburg, Stockholm-Malmö, Gothenburg-Malmö.
Other	The traction power supply is generally weak.	-

A1.2 Power generation

Data	Norway	Sweden
Direct supply from public network	No	No
Supply from public utility via rotary frequency converters	Yes	Yes
Supply from public utility via static frequency converters	Yes	Yes
Railway owned power stations / generators	Yes, but one hydro power station owned by other company (Statkraft SF)	No
Supply network structure	Decentralized, but a small centralized 55 kV network exists in the region south west of Oslo	Decentralized, including a 132 kV-feeding system which connects 8 converter stations
Frequency and phase stiffness	<p>Synchronous to public utility. See section 6.1.2 in the report.</p> <p>Transient deviation in frequency may occur due to changing load. Phase: For both rotary and static converters phase angle depends on load demand. For a load at $\cos(\varphi) = 1.0$ the phase normally lags 36° at converters at rated load.</p>	<p>Synchronous to public utility. See section 6.1.2 in the report.</p> <p>Transient deviation in frequency may occur due to changing load. Phase: For both rotary and static converters phase angle depends on load demand. For a load at $\cos(\varphi) = 1.0$ the phase normally lags 36° at converters at rated load.</p>

A1.2.1 Connection to public utility

Data	Norway	Sweden
Voltage level at connection point (PCC= point of common coupling)	min: 11 kV typ: 66 kV max: 130 kV	min: 70 kV typ: 130 kV max: 220 kV
Short circuit power at connection point (PCC= point of common coupling)	min: 70 MVA typ: 250 MVA max: 2500 MVA	min: 594 MVA typ: 2-3000 MVA max: 9260 MVA
Short circuit power at substation input	Not calculated	Without any contribution from rotary converters: min: 45 MVA

		typ: 150-200 MVA max: 480 MVA
Modifications planned in future	No information available.	Increased feeding capacity when new converters are commissioned.

A1.2.2 Power stations

Data	Norway	Sweden
Number of power stations	1	None
Number of generators per station	min: 2 typ: 2 max: 2	N.A. (= not applicable)
Rate generator power	min: 600 kW typ: 600 kW max: 600 kW	N.A.
Typical short circuit impedance of generator [%]	Unknown	N.A.
Typical short circuit impedance of transformer [%]	3.09+j0.978	N.A.
Modifications planned in future	Increasing generator capacity to 2500 kW	N.A.

A1.2.3 Rotary frequency converters

Data	Norway	Sweden
Converter name	ASEA Q24, Q38, Q48 and NEBB 7 MVA and 10 MVA	ASEA Q24/Q25 ASEA Q38/Q39 ASEA Q48/Q49
Number of converter stations	29	25 and 3 which have both rotary and static converters
Number of converters units per station	min: 1 typ: 2 max: 3	min: 2 typ: 3 max: 5
Type of converter	Synchronous to synchronous	Synchronous to synchronous
Type of excitation and control	Electro-mechanical	Electro-mechanical
Damping	Damping windings in generator-machine, none in motor-machine	Damping windings in generator-machine, none in motor-machine
Railway side connected to	Contact line for all, but also to 55 kV distribution network in two stations	Contact line
Regeneration capability	Yes	Yes

Rated converter power per unit [MVA]	min (Q24): 2.4 typ (Q38): 4 max (Q48): 10	min (Q24): 2.4 typ (Q38): 4 max (Q48): 10
Continuous power per unit (respectively) [MVA]	min (Q24): 3.1 typ (Q38): 5.8 max (Q48): 10	min (Q24): 3.1 typ (Q38): 5.8 max (Q48): 10
Typical short circuit impedance of generator+ Transformer [Ohm]	min (Q48): j7.0 typ (Q38): j14.35 max (Q24): j33.1	min (Q48): j7.0 typ (Q38): j14.35 max (Q24): j33.1
Voltage regulation	Stiff or slightly declining with increasing reactive power demand.	Stiff or slightly declining with increasing reactive power demand.
Capacity	The number of active units in each station is adapted to hourly variation in power demand	The number of active units in each station is depending on the actual load and adaptive load statistics.
Overloading capacity	Up to +40 % of continuous power for 6 minutes and +100 % of rated power for 2 seconds	Up to +40 % of continuous power for 6 minutes and +100 % of rated power for 2 seconds
If overloaded	Converter is instantaneously disconnected	Converter is instantaneously disconnected
Modifications planned in future	Static and brushless excitation may be implemented. Maybe increasing the number of converters in each station.	Brushless exciters may be introduced in the future.

A1.2.4 Static frequency converters

Data	Norway	Sweden
Converter name	ABB PWM converter ABB/Adtranz PWM converter: MegaMacs Siemens	ASEA Cyclo-converter: YOQC ASEA/ABB PWM-converter: TGTO ABB/ADtranz PWM-converter: MegaMacs ALSTOM PWM-converter
Number of converter stations	6	18
Number of converters units per station	min: 2 typ: 2 max: 3	min: 2 typ: 3 max: 4 6 in future
Type of converter	PWM converter: Line voltage converter (rectifier) and pulse width modulated	15 cyclo converters and 37 PWM conveters

	inverter connected together with DC-link	
Filters on railway side	Yes, broad band and psofometric filter	Normal filter configuration for cylco converters and MEGAMACS is a wideband filter. Normal filter configuration for other PWM converters is 6 th and 8 th and wideband
Other filters	DC-link: 2 nd , 4 th , 6 th and 8 th /9 th . Utility grid: Yes	DC-link: 2 nd , 4 th , 6 th and 8 th and wideband in MEGAMACS converters Utility grid: Yes
Regeneration capability	Only one station, in others the phase angle is shifted to push regenerated energy forward to other trains or stations. Some stations have a resistor for taking care of short term feedback power.	All cyclo converters can regenerate to the 50 Hz-grid. 2 converter stations with PWM-converters can regenerate to the 50 Hz grid. (Alingsås and Järna). All other PWM converters have resistors to take care of short term feedback power.
Rated converter power per unit [MVA]	min: 6 typ: 15 max: 15	min: 6 typ: 15 max: 15
Typical short circuit impedance of output transformer [%]	0.013+j0.0677 pu	0.83+j13.0 but can vary a lot: 0.83% > ur >1.49% 7.94% > ur >13.0%
Voltage regulation	Stiff or slightly declining with increasing reactive power demand. Static converters imitate the dynamical response of a rotary converter (ASEA Q48) due to software parameterisation. The 1~ phase voltage angle depends therefore of the 3~ phase angle.	Stiff or slightly declining with increasing reactive power demand. Static converters imitate the dynamical response of a rotary converter (ASEA Q48) due to software parameterisation. The 1~ phase voltage angle depends therefore of the 3~ phase angle.
Frequency regulation	Synchronization with the 50 Hz grid is kept by means for phase-locked loops	Synchronization with the 50 Hz grid is kept by means for phase-locked loops
Capacity	The number of active units in each station are automatically adapted to	The number of active units in each station is depending on the actual load and

	variation in power demand	adaptive load statistics.
Overloading capacity	No short time exceeding of rated power	Normally no overload capacity but MEGAMACS have a short time capacity of 17 MVA
If overloaded	If current limit is reached, voltage will be reduced. The voltage will then not be sine adapted.	If current limit is reached, voltage will be reduced. The voltage will then not be sine adapted.
Extensions planned in future		7 new static converters are under commissioning, in operation 2007-2008

A1.3 Power distribution

A1.3.1 General data

Data	Norway	Sweden
Railway owned power distribution network exists	Yes at 16.7 Hz, in one limited area	Yes at 16.7 Hz
Nominal voltage [kV]	55 (2 x 27.5 kV)	132 kV (2x66 kV)
Number of phases	2	2
Purpose	Connecting one hydro power station, 2 rotary converters and 3 substations	To reduce number of converter stations and have a more even usage of the remaining converter stations
Network length [km]	Approx. 157	1925
Total cable length	No information available.	Cables north of Uppsala of length 6 km and south of Uppsala 3 km. (these are the longest existing cable sections)
Lowest network resonance frequency [Hz]	No information available.	Normally 100 -130 Hz. Resonance frequencies lower resonance frequencies can occur (combinations of lines and connected installed power).
Modifications planned in future	No significant modifications	No significant modifications planned

A1.3.2 Transformer stations

Data	Norway	Sweden
Number of transformer stations	3 plain transformers, 2 located together with converter stations	31 plain transformers substations, 8 transformer substations located together with converter stations
Nominal power rating [MVA]	min: 2x2.5 typ: max: 1x8	All plain transformer substations have one 16 MVA transformer Most transformer substations at converter stations have two 25 MVA transformers but normally only one operating.
Short circuit impedance [%]	min: typ: 6.3-6.5 max:	min: typ: 5 max:
Efficiency in nominal point [%]	typ: 98-99	> 99 at $\cos(\varphi) = 1.0$
Voltage regulation	Typically none, but one station has automatic tap changer	Only tap changers, no on load tap changers.
Modifications planned in future	None	No

A1.3.3 Transmission lines

Data	Norway	Sweden
Typical transversal section (cross section)	55 kV (2x27.5 kV) normally made up with concrete poles and with the phase height of 9.2 m and phase spacing of 3.5 m.	132 kV lines (2x66 kV) are normally built with wooden poles with a phase height of 10.8 m (sags included) and a phase spacing of 4m. Earthed top wires only close to substations and on some lines where old 3-pase 220 kV lines have been reused.
Conductor material(s)	Cu and FeAl	DOVE: 329 mm ² FeAl
Conductor cross section (s) [mm ²]	4x35, 4x50, 2x50 and 2x70	See above.
Specific impedance [Ohm/km]	0.34+j0.24 or 0.73+j0.28	Positive sequence: 0.1025+j0.126 Ω/km Zero sequence: 0.1349+j0.456 Ω/km

		Pos.seq. capacitance: 9.5862 nF/km Zero seq. capacitance: 6.4444 nF/km
Modifications planned in future	No significant modifications	No significant modifications planned.

A1.3.4 Cables

Data	Norway	Sweden
Specific impedance [Ohm/km]	0.1+j0.03 or 0.12+j0.28	Per phase: 0.1009 + j 0.026
Specific capacitance [nF/km]	Per phase: 0.16 μF/km	Per phase: 0.16 μF/km
Modifications planned in future	No significant modifications	None known.

A1.4 Substations

A1.4.1 General data

Data	Norway	Sweden
Map	Se appendix 2	Se appendix 3
Number of substations	38	See section A1.2.4 and A1.3.2.
Type of substations	Transformers only: 3 Converters feeding contact line: 35 Hydro power station: 1	See references above
Nominal power rating of complete substation [MVA]	min: 2x0.625 typ: 2x5.8 max: 3x15	See references above
Feeding of railway lines	Single side Double side Multiple side (2 T-connections)	Single and double sided feeding.
Distance between substations [km]	min: 12 typ: 80 max: 92	See section A1.5.1.
Distance of single fed line [km]	min: typ: max: 63	See section A1.5.1.
Normal operation of network	Interconnected	Interconnected
Separation of feeding areas (neutral sections)	Seldom sectioned, but depending on operation of utility grid	Normally no separation of feeding areas.

Voltage at railway side	Controlled during operation	16.5 kV controlled during operation, stiff or slightly declining, proportional to the inductive load (slightly increasing at capacitive load)
Modifications planned in future	No information available.	More stations will have slightly declining voltage, proportional to the inductive load (slightly increasing at capacitive load)

A1.4.2 Autotransformers

Data	Norway	Sweden
Autotransformers exist	No, but planned in future	Yes, but only on single track lines
Voltages [kV]	2x15	2x15
Transformer rating [MVA]	min: typ: 5 max: 2x5	5 Normally two AT's in parallel are used as feeding transformer feeding an AT-line.
Short circuit impedance [%]	min: typ: 0.4 max:	uk = 0,4 %, 57.53° (or 0.184+j0.117 Ω)
Distance between trafos [km]	min: 8 typ: 10 max: 12	min: 8 typ: 10 max: 12
Present on ... fed lines	...both single and double side...	...both single and double ...
Connection of AT to lines	Negative feeder (-15 kV), rail (0 kV) and positive feeder (+15 kV). Positive feeder interconnected to contact line (sectioned) typical each 5 km.	Normal connection, i.e. negative feeder (-15 kV), rail (0 kV) and contact line as positive feeder (+15 kV).
Combination with other systems	Not planned	At some lines with booster transformers, i.e. some lines may in the future be converted into ATBT-system.
Modifications planned in future	Planned to be used for today's weak lines	More AT-system lines are planned. AT-system may occur on double track lines in the future.

A1.4.3 Passive filters and compensators

Data	Norway	Sweden
Passive filters exist	Yes	No, only at converter stations with static converters, see A1.2.4
Type of filter	Series capacitor and shunt capacitor	N.A.
Schematics etc.	No information available.	N.A.
Resonance frequencies	Series: No significant effects on resonance frequencies. Shunt: No information available.	N.A.
Where in service	Series capacitor between converter stations on weak lines, shunt capacitor in heavy load area (Oslo S)	N.A.
Purpose	Series capacitor for voltage increase and shunt capacitor for reactive power feeding	N.A.
Rating	Series cap $-j7.35$ [Ohm] Shunt cap 4 [MVar]	N.A.
Modifications planned in future	Series capacitors will probably be removed when line is reinforced/rebuilt with AT-system	More filters built when new converters are built

A1.4.4 Controlled filters, compensators and balancers

Data	Norway	Sweden
Controlled filters/ comp. exist	No	No
Type of installation	N.A.	N.A.
Schematics	N.A.	N.A.
Where in service	N.A.	N.A.
Purpose	N.A.	N.A.
Modifications planned in future	N.A.	N.A.

A1.4.5 Auxiliaries

Data	Norway	Sweden
Substation and station supply	Yes	Yes
Switch heating	Yes	Yes
Train heating	Yes	Yes

Any other equipment	No	See section 6.9.4 in the report.
Modifications planned in future	No information available.	None

A1.4.6 Other equipment

Data	Norway	Sweden
Other equipment exist	No	No
Description	N.A.	N.A.
Modifications planned in future	No information available.	None

A1.5 Railway lines

A1.5.1 Longitudinal characteristics

Data	Norway	Sweden
Map	See appendix 2	See appendix 3
Max length between feeding points [km]	92	156 (one weak line), normally 60-120 km but shorter in areas with heavy traffic, the longer distance reflects that 132 kV lines are present
Max length between feeding points and open line end [km]	63	63
Modifications planned in future	Introducing AT-systems, the max length between feeding points probably will be increased to 120 km	No specific modifications planned.

A1.5.2 Cross connections on double-track lines

Data	Norway	Sweden
Cross connection is done	Never in normal operation but one shorter line where the two tracks are operated parallel (connected in the ends)	Exists on some lines (Tranås-Malmö) as normal operation. On other lines only during fault conditions or maintenance.
Cross-connections (if existing) are	Switchable, but just in use in fault situations	Switchable.
Distance between connections (if existing)	min: typ: very variable max:	Normally 7-10 km.

Modifications planned in future	No information available.	More lines using cross connections are under investigations
---------------------------------	---------------------------	---

A1.5.3 Cross sections of lines

Data	Norway	Sweden
Number of tracks on open line (i.e. outside stations/yards)	Mostly single track, but double and multiple track exist	Normally single track but double track between the cities Stockholm, Gothenburg and Malmö and north and west of Stockholm, see Appendix 3, Network map of Sweden. In the Stockholm area 4 track lines exists.
Earth wire	On some lines, both sectioned and interconnected exist	Exists on some lines.
Feeder (electrically parallel to contact line)	Normally not, but exist on some lines	Only on a few lines.
Feeder (connection in switch posts only)	On some lines	Only at a few locations, e.g. in the Stockholm area.
Return conductor	On some lines, normally two 240 mm ² Al	Yes, normally two 212 mm ² Al
Auto-/booster wires	No information available.	BT-systems: Booster wire is normally (212 mm ² Al) used in the north of Sweden and some lines in the south, see Appendix 3, Network map of Sweden. AT-systems: Booster wire is normally used.
Public utility (no direct connection to railway system)	Not at all	None
Auxiliary supply (no direct to railway system)	Not at all	Auxiliary power of 3-phase 22 kV or 11 kV (also 2-phase exists) are normally placed on top of the contact line poles. This auxiliary power is normally fed from converter stations. Loads along the lines can also be fed from the public network. Transformers at loads along

		the line. The voltage is very weak
Open communication lines	On some lines	On most of the lines, placed in the embankment.
Typical cross section(s) layout(s)	No information available.	See appendix 6 for a typical BT-line and appendix 7 and 8 for AT-lines.
Any other important info	Isolation standard (target/planning level) for the contact overhead line system is 170/70 kV.	Isolation standard (target/planning level) for the contact overhead line system is 170/70 kV. There exists lines with isolation levels between 150/55 kV and 225/75 kV.
Modifications planned in future	No information available.	Earth wire are planned to be standard on all future AT-lines, probably also on BT-lines. Exits already on some lines.

A1.5.4 Cable sections

Data	Norway	Sweden
Length of cable connection substation to contact line [km]	typ: 0.1 max: 5	0.1 – 4 km, typical value 300 m.
Length of feeder cable parallel to railway line (e.g. tunnels, urban areas) [km]	typ: max: short	Exist only in the Stockholm area (4 cable feedings). Typical length : 13 km.
Specific impedance [Ohm/km]	min: 0.10+j0.03 typ: 0.12+j0.06 max:	For cables in the Stockholm area: 0.12 + j 0.054 and 0.15 + j 0.036
Specific capacitance [μ F/km]	min: typ: 0.26 max:	For cables in the Stockholm area: 0.16 and 0.26 μ F/km.
Modifications planned in future	Introducing AT-system may cables for negative and positive feeder in tunnels may be necessary	Under investigation (Citybanan in Stockholm).

A1.5.5 Return current arrangement

Data	Norway	Sweden
Rail types	S49: 2700 km S54: 750 km	Normally UIC 50 and UIC 60 or corresponding.

	UIC60: ca. 200 km	
Rail info	Normally welded, isolated gaps/joints exists	One rail welded (S-rail) and one rail with isolated joints (I-rail) which is used by the DC-track signalling circuit.
Isolated rails	No isolation at all	Yes, see item above.
Return conductor	See section A1.5.3.	See section A1.5.3.
Earth wire	On some lines, both sectioned and interconnected (typical distance between connections to rail is 3 km) exist	See section A1.5.3.
Track transformers	No	No
Other characteristics	No	No
Earth resistivity [Ωm] Wet soil: 20-200 Humus/clay: 50-200 Wet sand: 100-300 Dry sand: 1000-50000 Mountains: 1000-10000	Railway lines are very often build on bedrock ground or rocky ground. A usable value is 2500 Ωm .	Earth resistivity is high. A usable value is 2500 Ωm .
Future modifications plans	No information available.	None

A1.5.6 Booster transformers

Data	Norway	Sweden
Booster transformers exist	Yes	Yes, on all lines except AT-system lines.
Transformer power rating [kVA]	min: 33 (380 A, 87 V) typ: 55 (680 A, 92 V) max: 95 (800 A, 118 V)	500 A Booster transformer: 158 kVA (500 A, 316 V, 800 A for 1 hour). Older booster transformers of 300 A exists.
Short circuit impedance [%]	min: 2.7 + j 2.5 typ: 8.4 + j 22.3	500 A Booster transformer: typ: 3.86 + j 10.3 typ: 11 (absolute value)
Distance between booster transformers [km]	min: 2 typ: 3 max: 20	typ: 5.6
Specific contact line system impedance [Ohm/km]	typ: 0.013	See section A1.5.9.
Modifications planned in future	No information available.	3-windings boosters may be introduced if ATBT-systems are introduced.

A1.5.7 Neutral sections/Phase gaps

Data	Norway	Sweden
Neutral sections exist	Yes	Yes
Neutral part is	See clause 6.2 in the report.	Normally floating
Location	See clause 6.2 in the report.	At substations and switching posts.
May be shunted	See clause 6.2 in the report.	Yes, normally to earth, but to contact line voltage exists.
Length [m]	min: 40 typ: 90 max: 350	min: 2 at stations min: 60 typ: 180 max: 180
Concept for emergency supply (e.g. one substation out of order)	No information available.	Converter stations are design for outage of one converter unit with out influencing the traffic.
Modifications planned in future	Neutral sections of 402 m are planned for future.	None

A1.5.8 Interaction AC/DC railways

Data	Norway	Sweden
Infrastructure segment lies adjacent to DC-railways/tramways	Yes	Yes
Special arrangements (such as DC train supply with current return through rails on AC lines)	No, not as we know	No
Description	Grefsen station (750 V DC parallel and 600 V DC crossing) Bryn station (750 V DC crossing) Trondheim station (600 V DC crossing)	Trams lines (750 V DC) parallel to railway lines in Gothenburg. Underground/subway lines (750 V DC) parallel to railway lines in Stockholm.
Modifications planned in future	Lysaker station – tramway face to face planned	No

A1.5.9 Numerical values BT system

Data	Norway	Sweden
Line impedance , single track lines [Ohm/km] including BT	min: 0.092+j0.106 typ: 0.190+j0.210 max: 0.233+j0.228	min: 0.13+j0.16 typ: 0.21+j0.20 max: 0.30+j0.23
Line impedance , double track lines [Ohm/km] including BT	min: 0.160+j0.180 typ: max: 0.218+j0.188	Not calculated.
Specific capacitance, single track [nF/km] (catenary–earth)	min: 9 typ: max: 17	typical for booster transformer lines: 8.8 – 11.1
Lowest resonance frequency (contact line network) double side feeding [Hz]	typ: 800 Hz global typ: 450 Hz local	typ: 800 Hz global typ: 450 Hz local
Lowest resonance frequency (contact line network) single side feeding [Hz]	typ: 450 Hz local	typ: 450 Hz local
Other interesting values	Earth resistivity is high.	Earth resistivity is high. A usable value is 2500 Ωm.
Modifications planned in future	No information available.	No

A1.5.10 Numerical values AT system

Data	Norway	Sweden
Fixed impedance at feeding or starting points [Ohm]	Not yet decided or calculated.	min: 0.189+j0.343 typ: max: 0.468+j0.755 (see note below the table)
Line impedance on single line track [Ohm/km]	Not yet decided or calculated.	min: 0.0335+j0.031 typ: max: 0.0715+j0.066 (linear approximations including AT's)
Line impedance on double line track [Ohm/km]	Not yet decided or calculated.	Not calculated.
Specific capacitance, single track [nF/km] (catenary–earth)	Not yet decided or calculated.	typ: 11.9 – 13.5
Specific capacitance, double track [nF/km] (catenary–earth)	Not yet decided or calculated.	Not calculated.
Lowest resonance frequency (contact line network) double	typ: 450 Hz global typ: 350 Hz local	typ: 400 Hz global typ: 250 Hz local

side feeding [Hz]		
Lowest resonance frequency (contact line network) single side feeding [Hz]	typ: 200 Hz local	typ: <200 Hz local
Modifications planned in future	Exact system design not decided yet	No

NOTE that the values for AT-systems in Sweden regards single track systems. Furthermore note that the AT-system impedances are linear approximations of the AT-system impedances with the intension to get values which can easily be used in simulation programs and for calculations of settings of relay protections. The fixed impedance corresponds approximately to the level of the zero sequence impedance of the system. This impedance shall be placed as a fixed impedance at both ends of the system in case of a AT-system fed from both ends and at the feeding end in case of a single end fed system. The impedance per km corresponds approximately to the positive sequence impedance.

A1.6 Signalling equipment

A1.6.1 Track circuits

Data	Norway	Sweden
DC track circuits	Only on non-electrified lines and at one electrified railway station (Filipstad)	DC track signalling circuits exists on nearly the whole network. None existing only on none electrified lines.
High voltage impulse	Do not exist	Do not exist
Low frequency (25-275 Hz)	Exist on most of the electrified lines. 95 and 105 Hz only, uncoded.	Do not exist
Reed frequency (275-1000Hz)	Do not exist	Do not exist
Lower audio frequency (1-4 kHz)	Exist on a small part of the network. Bombardier TI 21 (1.5 - 2.6 kHz), digital processor based and not transmitter signal coded.	Do not exist
Upper audio frequency (4-20 kHz)	Exist on a part (110 km) of network. Siemens FTGS (4.7-16.5 kHz), digital and transmitter signal coded.	Do not exist
Other	Do not exist	Train radio or radio blocking of trains on some none electrified low traffic lines
Modifications planned in future	No information available.	More radio block systems are planned for low traffic

		lines.
--	--	--------

A1.6.2 Axle counters

Data	Norway	Sweden
Mechanical	Do not exist	No
Electro-magnetic	Do not exist	Yes, but not used as signalling equipment They are placed together with axle box heating locked braking detectors
Electronic	Do not exist, but are being tested	No
Others	Do not exist	No
Modifications planned in future	Are planned for future use	None

A1.6.3 Automatic train protection (ATP) and automatic train control (ATC)

Data	Norway	Sweden
ETCS/ERTMS level 1	Does not exist	Does not exist.
ETCS/ERTMS level 2	Does not exist	Introduced on the Botniabanan
ETCS/ERTMS level 3	Does not exist	Does not exist.
National system(s)	“ATC” used in nearly the whole network. EBICAB700 manufactured by ATSS and Bombardier	“ATC” used in nearly the whole network, manufactured by ATSS and Bombardier. Radio blocking of trains or manual train blocking used on some none electrified low traffic lines.
Modifications planned in future	Long term strategy is ERTMS level 2	Ongoing project for introducing ERTMS level 2 (the lines Malmö-Stockholm-Sundsvall are planed for 2010-2015)

A1.6.4 Interference monitors

Data	Norway	Sweden
Philosophy of application	Monitors recommended. Monitors needed if safety case can not be fulfilled otherwise	DC-current monitor on new electrical traction vehicles is required.

Purpose	Monitored frequencies: 95 and 105 Hz. Trip level 2 A rms. Filter characteristics ± 3 Hz. Response time 1 sec.	To monitor the DC-component, a component which can have an influence on the track signalling circuits.
Type(s) in service	95 and 105 Hz monitor for warning and disconnection of main circuit breaker.	DC-monitors are in operation on some new vehicles.
Modifications planned in future	No information available.	None

A1.6.5 Interference limits

Data	Norway	Sweden
Frequency band (name)	See section 5.2 and 5.4 in the report.	Limits on DC-components and psophometric currents, see section 5.2 and 5.4 in the report.

A1.6.6 Data transmission and remote control systems

Data	Norway	Sweden
System(s)	Various communication systems exists, such as PCM (puls code modulation, BF (frequency carrier), etc, on Cu-cable. Also ordinary telephone lines on Cu-cables exists. Opto-communication is the dominating transmission for long distances communication. GSM-R is being introduced in the whole country.	Various communication systems exists, such as PCM (puls code modulation, BF (frequency carrier), ADSL, etc, on Cu-cable. Also ordinary telephone lines on Cu-cables exists. Opto-communication is the dominating transmission for long distances communication. Transmission used for SCADA-systems are ELCOM, X25, RP570 and more. At the moment IEC 870-5-104 (on TCP/IP) is introduced. GSM-R is being introduced in the whole country.

A1.7 Operational conditions

A1.7.1 Line frequency

See section 6.1.2.1 in the report.

A1.7.2 Line voltage RMS value

See section 6.1.1.1 in the report.

Based on simulation in SIMPOW® TRACFEED® the figures below show a typical statistical distribution of the fundamental voltage at the pantograph of a vehicle in Norway. The values can be used as a fairly good approximation also for Sweden.

The information is based on 1-second values (mean values during one second) for a 35 different trains considered as representative of the operation to day. Vehicle and line vary and the trains are divided and aggregated into the following groups:

- Freight trains on long distance lines, normally considered as weak lines (Bergen line, Dovre line, Sørland line and Ofoten line).
- Passenger trains on long distance lines, normally considered as weak lines (Bergen line, Dovre line, Sørland line and Ofoten line).
- Passenger trains in Oslo area, also including the Gjøvik line, Østfold line and the Vestfold line. The Oslo area is normally considered as relatively stiff compared to long distance lines.

The voltages shown below are simulated for traction, coasting and braking mode and includes stops at stations between start and stop.

Note that this figures show an overall distribution. For shorter time intervals the voltage distribution for a single train deviates from the figures shown due to sections of lines with lower voltage quality.

Freight trains on long distance lines

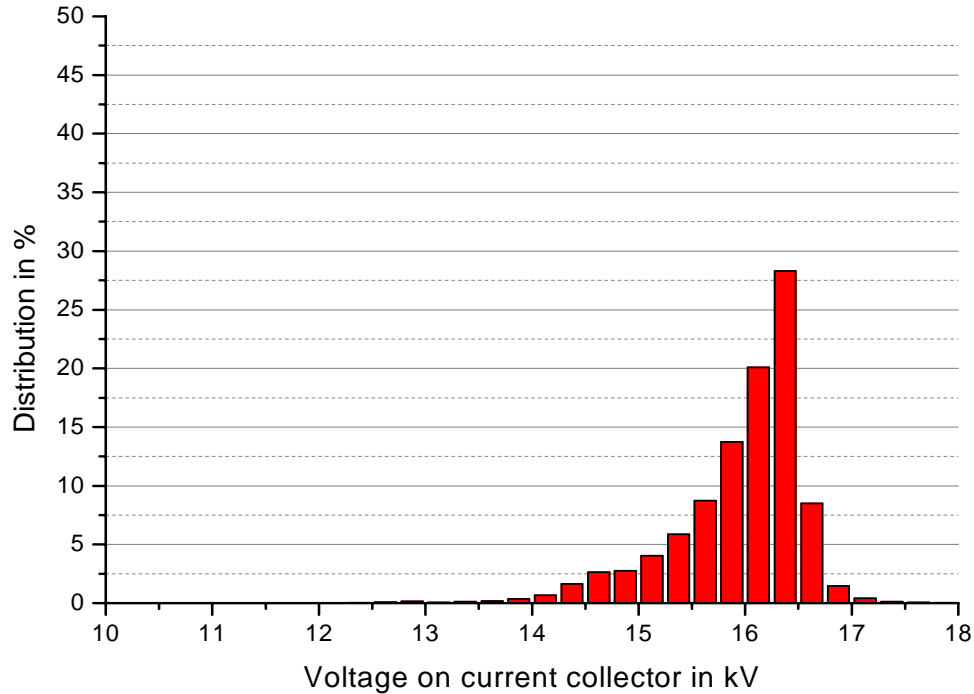

Passenger trains on long distance lines

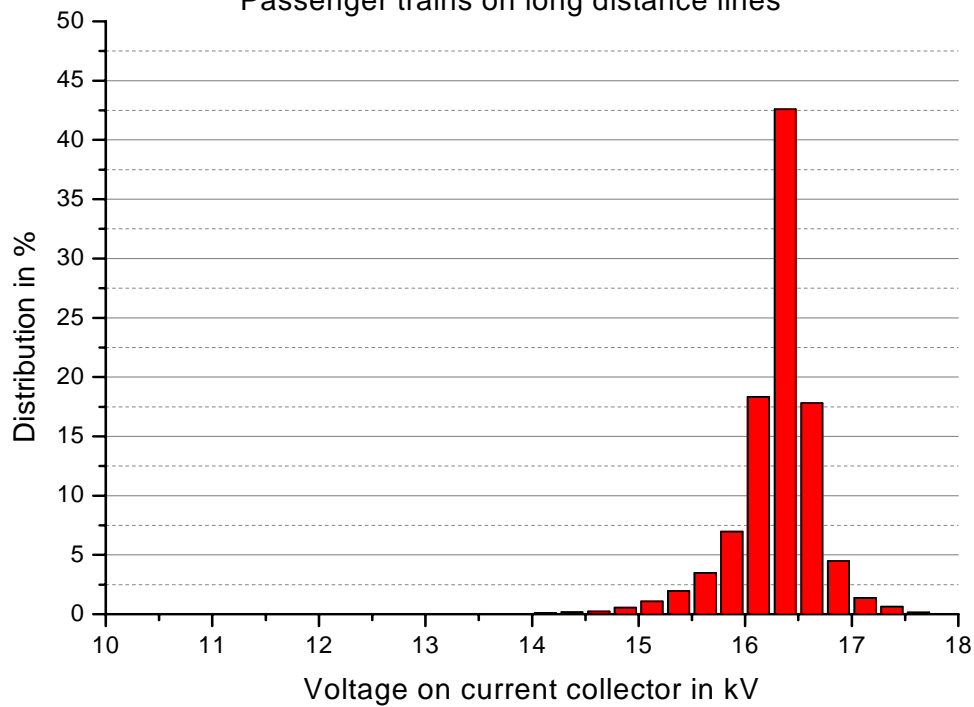

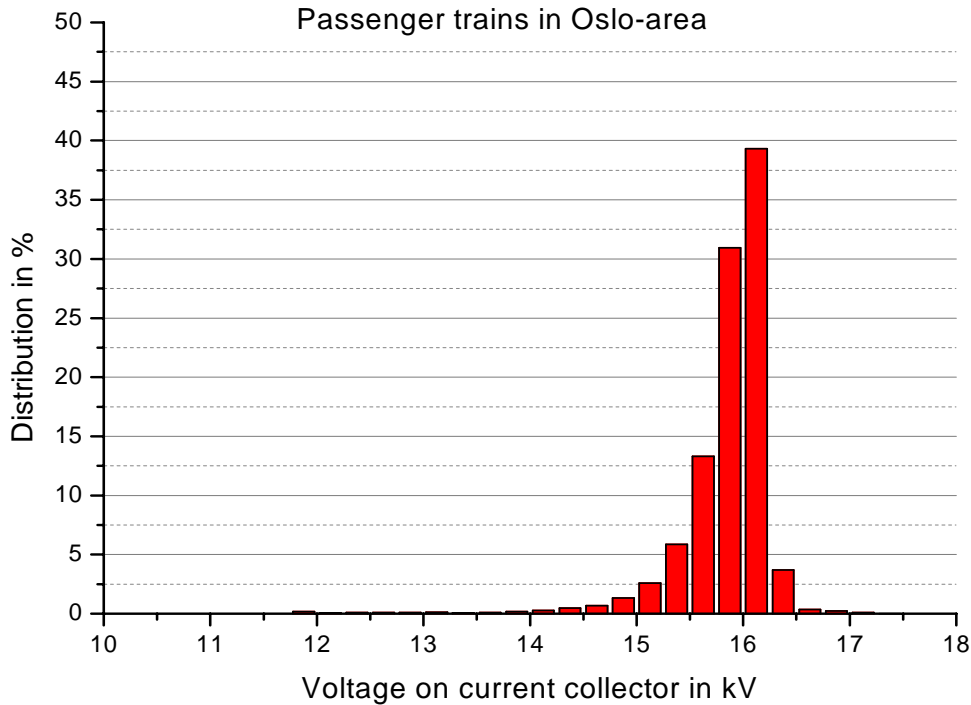

A1.7.3 Line voltage spectrum

Data	Norway	Sweden
Sub-harmonics or regular frequency variations occur	Yes, see clause 6.5.1 in the report.	Yes, see clause 6.5.1 in the report.
Line voltage content with harmonics up to 1000 Hz	Significant to very large, higher harmonic orders do occur but are not significant, see section 6.1.3.1 in the report.	Significant to very large, higher harmonic orders do occur but are not significant, see section 6.1.3.1 in the report.
Line voltage content with harmonics 1000-3000 Hz	Very low, no influence on vehicle known from earlier tests	Very low, no influence on vehicle known from earlier tests, so far.
Typical spectra	See section 6.1.3.1 in the report.	See section 6.1.3.1 in the report.

The figure below can be regarded as a typical statistical distribution of the line voltage harmonics for Norway and Sweden. (The values of the figure below are based on recordings made during tests with a locomotive on the Borlänge-Ludvika/Krylbo-Frövi-Eskilstuna line sections in Central Sweden, October 2005. Recordings and analysis by L. Buhrkall.)

Typical distribution of line voltage interference components, measured in Central Sweden.

PLEASE NOTICE: The curves showing the distribution of the fundamental 16 2/3 Hz voltage components are not typical for low voltages at weak supply.

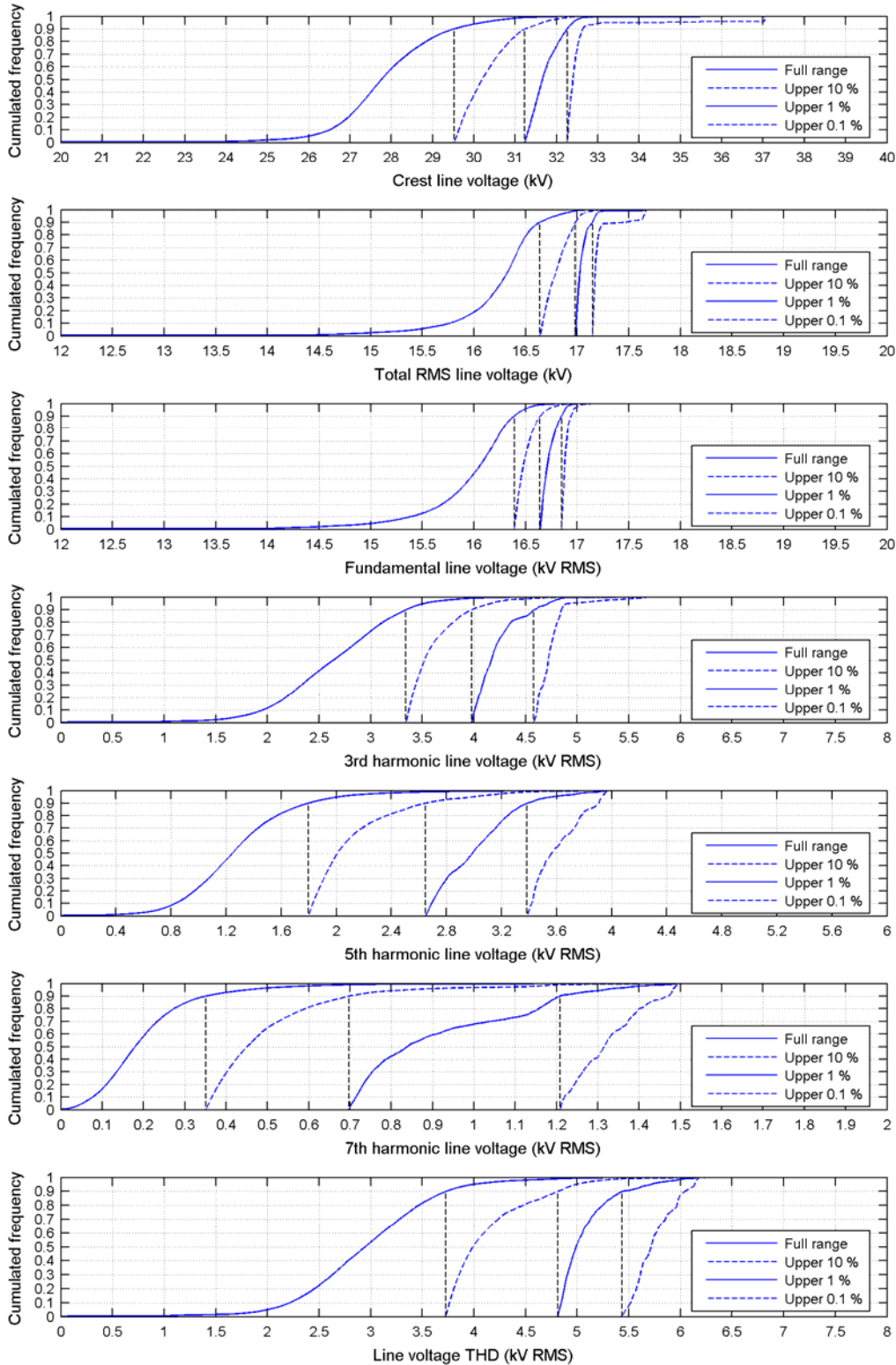

A1.7.4 Regenerative brake

See clause 6.8 in the report.

A1.7.5 Power factor

See clause 6.3 in the report.

A1.7.6 Earthing

Data	Norway	Sweden
Earthing principles	The midpoint of the 2x27.5 kV high transmission line is directly earthed.	The 132 kV system has directly earthed midpoints in the 2-phase system (2x66 kV). AT-systems (2x15 kV) have directly earthed midpoints.

A1.7.7 Traffic information/characterisation

Data	Norway	Sweden
City area	Train density equal to line capacity	Train density equal to line capacity
Suburban area	Train density equal to line capacity	Train density equal to line capacity
Long distance lines	0-6 trains per feeding distance depending on traffic. In high load periods up to or even higher than line capacity.	Some lines (south from Storvik and south from Hallsberg to Mjölby) has train density equal to line capacity. Otherwise 0-6 trains per feeding distance.

See respective Network Statement.

A1.7.8 Network operation

Data	Norway	Sweden
Case	The network is normally interconnected with adapted feeding capacity. Sectioning of contact line due to maintenance or failure often occur. Maintenance of converter stations may result in reduced feeding capacity. Sectioning and reduced feeding capacity results in lower resonance frequencies	Single feeding of lines during maintenance or fault conditions may occur resulting in very high impedances at the far end from feeding point and lower resonance frequencies. Other cases not applicable for vehicle compatibility

A1.7.9 Infrastructure classes

Expressions used in table below correspond to the definitions in EN50 163 and EN 50388.

For more details see corresponding chapters in the report. Classification of infrastructure is to be given in respective Network Statement, but classes written in *italic* are most used.

Data	Norway	Sweden
Line voltage levels	<i>V1: according to EN 50163:2004</i> V2: $U_{\min 2}=10000$ V and $U_{\min 1}=11000$ V	<i>V1: $U_{\max 2} = 17500$ V</i>
Maximum current limitation	C1: $I_{\max} = 1200$ A C2: $I_{\max} = 900$ A C3: $I_{\max} = 700$ A	Max current per train is 900 A in tractive mode. Higher values in braking mode can be accepted.
Regenerative braking	B1: I_{\max} B2: 10 MW B3: 8 MW <i>B4: 5 MW</i>	No classes defined.
Low frequency power oscillations	Under investigation.	Under investigation.

A1.8 Existing electrical vehicles

Passive filters refers to HV-filters or filters on a separate winding of the transformer, not filters on the DC-link in case of an inverter vehicle.

Active behaviour refers to if the control system compensate for harmonics in the traction current in order to draw a sinusoidal current

A1.8.1 Electrical locomotives in Norway and Sweden

Operator	Vehicle (no of vehicles in op. in brackets.)	Type	Passive filter	Active behaviour
Not yet in operation in Norway and Sweden	BR 185 (none yet)	Inverter	Yes	yes
Hector Rail AB (preliminary accepted)	BR 441 (2) (DB BR 189)	Inverter	Yes	up to 83 1/3 Hz
Hector Rail AB	BR141 (3) (ÖBB Class 1012)	Inverter	No	up to 250 Hz
Hector Rail AB	BR142 (6) (ÖBB Class 1142)	Tap changer	No	No
MTAB	Dm 3 (19)	Tap changer	No	No
MTAB, TKAB	Da (5)	Tap changer	No	No
Raillion AS	EG 3100 (13)	Inverter	Yes	Yes, up to unknown freq.
NSB AS, Ofotbanen AS	E1 13 (5)	Tap changer	No	No
CargoNet AS	E1 14 (31)	Tap changer	No	No
Hector Rail AB	E1 15 / BR 161 (6)	Tap changer, diode rectifier	No	No
CargoNet AS, TKAB, TGOJ	E1 16 (17)	Phase angle control	Yes	No
NSB AS	E1 17 (10)	Inverter	Yes	Unknown
NSB AS	E1 18 (22)	Inverter	No	up to 83 1/3 Hz
MTAB	IORE (2x9=18)	Inverter	Yes	up to 83 1/3 Hz
TGOJ	MA (32)	Tap changer	No	No
SJ AB, Green Cargo AB, TÅGAB, TGOJ	Rc 1 to Rc 7 (356)	Phase angle control	Yes	No
Green Cargo AB	Rm (6)	Phase angle control	Yes	No

A1.8.2 Electrical multiple units in Norway and Sweden

Ofofbanen AS	Class 68 (3)	Tap changer	No	No
NSB AS	Class 69 a-g (77)	Phase angle control	a-c: yes d-g: no	No
NSB AS	Class 70 ("IC 70")	Inverter	No	up to about 300 Hz
Flytoget AS	Class 71 ("FPT")	Inverter	No	up to about 850 Hz
NSB AS	Class 72 (36)	Inverter	No	Unknown
NSB AS	Class 73 (22) Identical to class 71	Inverter	No	up to about 850 Hz
SL	X1 (94)	Phase angle control	Yes	No
SJ	X2 ("X 2000")	Inverter	Yes	up to 216 2/3 Hz
Arlanda Banan AB	X3 (7) ("Arlanda Express")	Inverter	No	unknown
SJ and SL and other regional operators	X10 to X14 (137)	Phase angle control	yes	No
SJ, TKAB	X20 to X23 (3)	Tap changer, diode rectifier	unknown	No
SJ / DSB	X31-32 (3x53) ("Öresund train")	Inverter	yes	unknown
SJ	X40 (2x16 and 3x27 ordered)	Inverter	no	up to 150 Hz
SJ and regional operators	X50-54 (50) ("Regina")	Inverter	yes	up to 83 1/3 Hz
SL	X60 (71 ordered)	Inverter	no	up to 150 Hz

(for a good general overview of vehicles in NO and SE see also www.jarnvag.net)

A2 APPENDIX 2: NETWORK MAP NORWAY

SS = Stationary static converter
SR = Stationary rotary converter
R = rotary converter
Maximum continuously capacity given in parentes

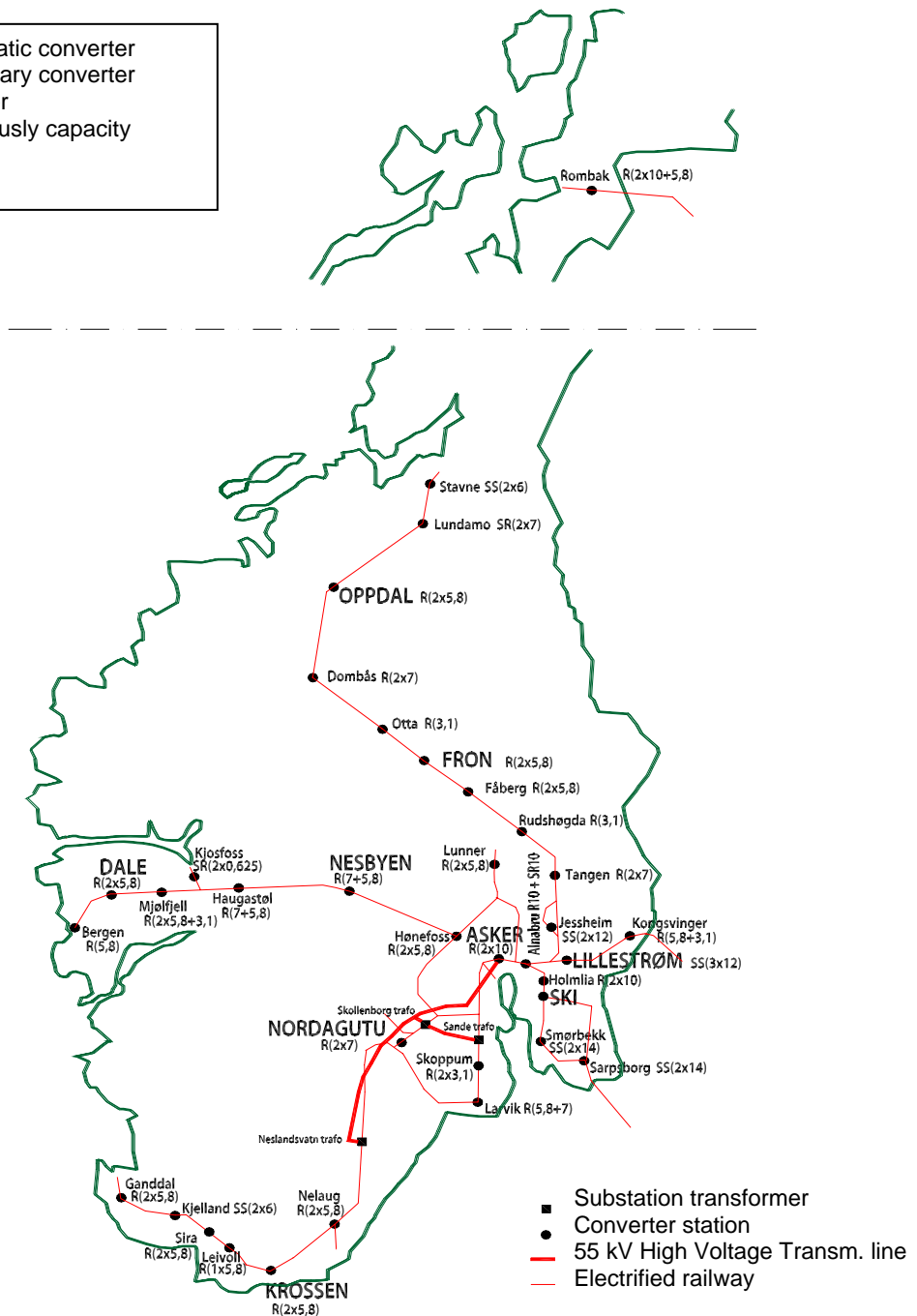





















A3 APPENDIX 3: NETWORK MAP SWEDEN

Railway map of Sweden with power supply facilities



2005-10-01

Legend:

-  Electrified line, BT-system 15 kV 16.7 Hz, 1 return conductor
-  Electrified line, BT-system 15 kV 16.7 Hz, 2 return conductors
-  Electrified line, BT-system 15 kV 16.7 Hz, 1 line feeder, 2 return conductors,
-  Electrified line, AT-system 2x15 kV 16.7 Hz
-  Electrified line, double track
-  Electrified line, double track with interconnections along the line
-  Non electrified line
-  **Murjek** Substation with rotating converters
-  **Ange** Substation with static converters
-  **Moholm** Substation with both static converters and rotating converters
-  Feeding line – overhead line, 132 kV, 16.7 Hz
-  **Ramsjö** Transformer substation, 16.7 Hz, 132/16.5 kV
-  **FL** Feeder - overhead line, 15 or 32 kV
PC Feeder - cable, usually 15 kV
-  Transformer substation, 32/16 kV
-  **Lund** Switching station with several 15 kV supply branches
-  **Perstorp** Switching station with one 15 kV circuit breaker only
-  **Stenungsund** Switching station with one 15 kV circuit breaker only old model mounted on pole
-  **Stockholm C** Switching station with disconnectors only
-  Region border of Banverket
-  **DLC** Dispatch centre



North Region
of Banverket

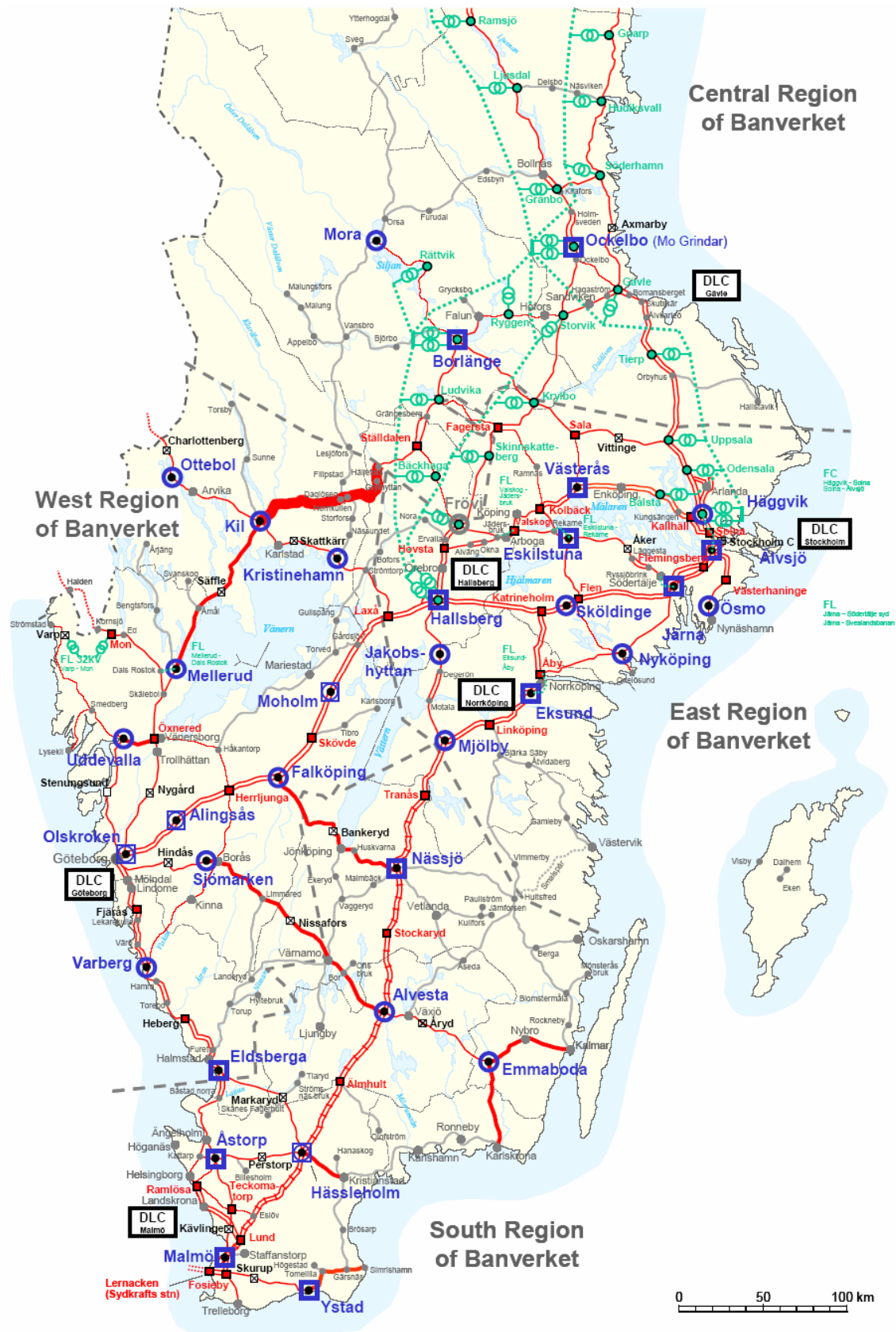

A4 APPENDIX 4: ADDITIONAL INFORMATION FOR STABILITY STUDIES

A4.1 Low frequency power oscillations

A4.1.1 Background

- Inverter vehicles typically control the line current and the dc link voltage depending on the train's operation point and the line voltage. The involved control loop includes the substation (rotary or static), the ohmic-inductive line and the vehicle's dc link capacitors. All these elements store and exchange energy. The number of vehicles, the impedance of the line and the tuning of the controllers have a large influence on the stability margin of the control loop.
- Responsible for the oscillations are the time delays and the tuning of the vehicle controllers. With increasing line impedance and number of vehicles instabilities can occur. The resulting oscillations have an eigen-frequency up to half the line frequency (e.g. 8 Hz) and lead to low frequent variations in the line voltage (phase and amplitude), pole angle of rotary converters, dc link voltage and motor torque. An unstable situation can also lead to protective shutdown of vehicles and / or infrastructure.
- This means that if a vehicle is controlled to consume constant active power by increasing its current when the voltage at pantograph decreases it can cause pole angle oscillations in a rotary converter. The variation in current is enough to give active overhead contact line losses which may obstruct damping of the oscillation or excite pole angle oscillation in the converter (pole angle oscillations in rotary converters are mostly excited by variations in active power load which consists of both train load and transmission losses).
- There are also vehicle controllers which act in a discontinuous way, e.g. adhesion control (sudden reduction of motor torque to prevent wheel slip) or line voltage limitation (to prevent breakdown of voltage at pantograph). Such interventions provoke the power supply system to answer with a step response, which is not critical by itself. However, if the action is continued repetitively and with frequencies close to eigen-frequencies of the supply system, low frequency oscillations may occur. This effect could occur both with inverter and phase angle controlled vehicles.

A4.1.2 Definition of a simulation model

- According to earlier projects the described effects can be reproduced in time domain simulations with a good accuracy.
- The simulation model must contain all relevant subsystems. It can either be off line or based on a hardware-in-the-loop simulation including a real-time simulator and the original control units. The modelling depth must be chosen such that the critical effects can be reproduced in simulation. The model should contain the following subsystems:
 - A vehicle model with a transformer, line converter including controller with accurate timing (time discrete implementation with sampling and delay

effects), DC link and the motor side with motor inverter including controller and motors to simulate the load.

- Line with adjustable impedance. An R-L-impedance is sufficient. The parameters are provided by the infrastructure manager (see chapter A1.5.9 and A1.5.10 of this document).
- Substation (rotary converters). The dynamic behaviour is provided by the infrastructure manager, see chapter A5 of this document. No models of static converters can be given, since they include proprietary knowledge of the respective manufacturer, but some time constants should however be possible to retrieve. Experience so far has shown that the vehicles are compatible with static converters if they are compatible with the rotary ones for all required operational conditions.

A4.1.3 Stability study

- Based on the simulation model as described above, a stability analysis of the new vehicle together with the existing power supply system has to be performed.
- It has to be shown that neither self excited oscillations due to feedback effects nor repetitive excitation of power system resonances due to discontinuous controllers occurs.
- Typical parameters for this sensitivity analysis can be taken from Appendix 1: Infrastructure data and related Information of this document. Minimum / maximum values have to be taken into account as well, but it is not necessary to combine all values to a “worst worst” case.
- The parameters (power supply, operation) on which the stability margin (and therefore the acceptance criterion) is based may be quite different for various types of operation (long distance freight traffic, or rapid mass transit) and can not be given with concrete values in this document. They have to be defined and agreed between vehicle manufacturer, operator and infrastructure manager right at the beginning of the study (EN 50 388:2005, clause 10, steps 1 and 7 of the compatibility process). They must be realistic for the planned operation, including a sufficient margin to guarantee stable operation.
- It has to be shown that the stability of the system is robust. The goal is to show that the foreseen operation is stable with sufficient margins. (Example: “It is possible to run up to 10 vehicles at the end of a 50 km long line. Only 4 are required. There is enough stability margin.”).
- Testing of the vehicle (EN 50388:2005, clause 14) will be based on the same conditions as for the simulation studies.

A4.2 Electrical resonance stability

A4.2.1 Background

- The control of the line inverter (four-quadrant power converter) of a vehicle reacts on the line voltage with short time constants, since the control e.g. has to shape the line current regardless of the line voltage waveform, or has to suppress specific frequency contents in the line current (compatibility with signalling installations). Delay times in

this reaction are inevitable, due to both microprocessor control cycles and pulse width modulation (PWM).

- Seen from the power supply system, the vehicle has a frequency response of its input admittance $Y(f)$, i.e. the ratio between line current and line voltage. If the admittance has a phase angle above / below $\pm 90^\circ$ (i.e. $\text{Re}(Y) < 0$) the vehicle is „active“ on the corresponding frequency, and may excite power system or filter resonances. This leads to corresponding instabilities and overvoltages. Such resonance and instability effects occur on frequencies higher than the line frequency. Linear or linearised methods can be applied for a stability analysis.
- Note that anti-control of a frequency component in the primary current of a vehicle (e.g. a 100-Hz anti-control) can result in the fact that the vehicle is active around this frequency.
- Most critical with respect to electrical resonance stability is the lowest system resonance frequency. This is valid for all type of networks. In contact line network, this frequency is typically between 800 and 1500 Hz in central Europe, but lower in Finland, Norway and Sweden due to the system build-up in these countries, i.e. booster transformer systems. It but may be even lower if a lot of cables are installed or if the lines are very long. The lower the frequency, the worse the damping is. Natural damping is mainly caused by eddy current losses in synchronous machines and substation transformers. Excessive cabling may lower the resonance frequency to critical values.
- Typical resonance frequencies in a 132-kV network are between 100 and 200 Hz, strongly depending on the geographical extension of the network as well as on the installed generator power. High voltage networks (including autotransformer systems) are, therefore, critical with respect to electrical resonance stability. Compared to filter resonances in converter stations or vehicles, transmission network resonances are much more critical due to their lower damping.
- Both static frequency converters and vehicles can include passive filter components, in order to reduce harmonic currents produced by the converter. These filters have resonances, which can also be excited to oscillations by the line converter control of vehicles. The situation is less critical compared to resonances in contact line and high voltage lines since the filters include damping resistors.

A4.2.2 Definition of a simulation model

- For electrical resonance stability investigations with respect to vehicle requirements as defined in this document, only a vehicle simulation model is required.
- The model must have a similar form as described above for low frequency oscillations.
- It is very important that all sampling and time delay effects (controllers, pulse width modulation) are correctly included.
- The motor side of the vehicle can be omitted if no fast feedback from the motor side to the line-side inverter and current circuits exists.

A4.2.3 Stability study

- The frequency response of the input admittance of the vehicle has to be simulated with the model as defined above.
- The frequency response has to be simulated for different operation points (typically zero power, maximum traction power, maximum braking power).
- As long as the vehicle holds the requirements as defined in the main part of this document (section 6.5.2) no simulation of the power supply network and other vehicles is necessary. If a vehicle can not hold this requirement, a full stability study according to EN 50388:2005, clause 10, has to be performed in order to demonstrate that the vehicle is stable together with the railway system.

A5 APPENDIX 5: DYNAMIC BEHAVIOUR OF ROTARY CONVERTERS

A5.1 Summary

The following general characteristics apply to rotary converter units:

- Even small steps in contact line power excite noticeable oscillation in the converter rotor.
- The direction of the power step (increase or decrease) has no significance for the magnitude of the rotor oscillation.
- The oscillation magnitude decreases greatly when power consumption occurs as a ramp of limited steepness instead of as a step.
- Even small repetitive power changes of limited steepness cause considerable oscillation when occurring at an unfavourable frequency (1.0 – 2.0 Hz). If a relative steep reduction of power under certain conditions is necessary, e.g. due to the function of wheel slip and slide protection, the amount of oscillation may to some extent be limited by imposing considerably stricter restrictions on following power increase.
- The time until an oscillation is damped increase with the oscillation magnitude, and is for large oscillations of the size of 10 – 15 s when rolling stock does not contribute to maintaining the oscillation.
- The rotor oscillation results in oscillations in the contact line voltage amplitude and the voltage's steepness and zero crossing every $16 \frac{2}{3}$ Hz period is displaced relative to a ideal sine.
- Depending on the train current-voltage characteristic, the contact line impedance may result in deviation between the voltage oscillation amplitude at the pantograph and at the converter station. Trains having power output independent of voltage will increase the amplitude while the amplitude will decrease for constant impedance load characteristic trains.

A5.2 Examples of converter unit response to changes in load.

A5.2.1 Introduction

The dynamic behaviour of rotary converter units is in the following text illustrated by computer simulations for a 5.8 MVA rotary converter unit (Q38) which on the single-phase side supplies the train without interconnection with other converter units. The train is simulated with voltage independent power consumption. Further description of the simulation model can be given by Norwegian National Rail Administration on request.

A5.2.2 Definitions

Definitions/Abbreviations used:

- U 60km: Pantograph voltage at 60 km from the converter station when contact line has a resistance of 0.18 ohm/km and an inductive reactance of 0.19 ohm/km (16 2/3 Hz)
- PA 60km: Angle of pantograph voltage at 60km from the converter station when overhead contact line has a resistance of 0.18 ohm/km and an inductive reactance of 0.19 ohm/km (16 2/3 Hz). Phase angle is relative to the 50 Hz power supply of the converter station.

A5.2.3 Frequency response

Figure 4b.1 shows the converter unit's frequency response characteristics for active power between the single-phase and the 3-phase side in the 0 – 5 Hz frequency band, i.e. the dynamic, electromechanical connection between a single-phase power disturbance $\Delta P1$ and the response in 3-phase power $\Delta P3$ for the converter unit. It is assumed that the disturbance is sine shaped.

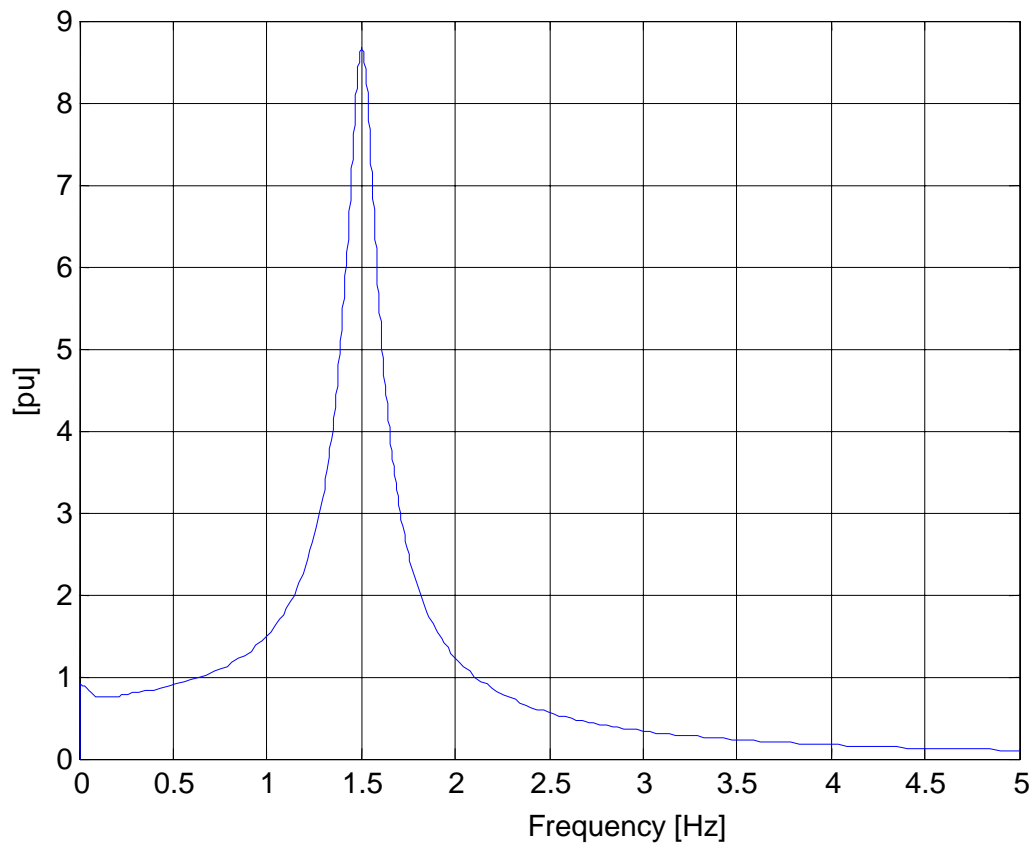

Figure A5-1 Example of the converter unit’s frequency response characteristic, $\Delta P3/\Delta P1$, for sine shaped change in single-phase power $\Delta P1$.

The frequency response characteristic for this converter unit has a distinctive resonance crest at approximately 1.5 Hz with an amplification of 9 pu.

A5.2.4 Active power step response

The voltage oscillations shown in the figures below arise due to changes in the converter rotor velocity when the converter’s pole angle oscillates.

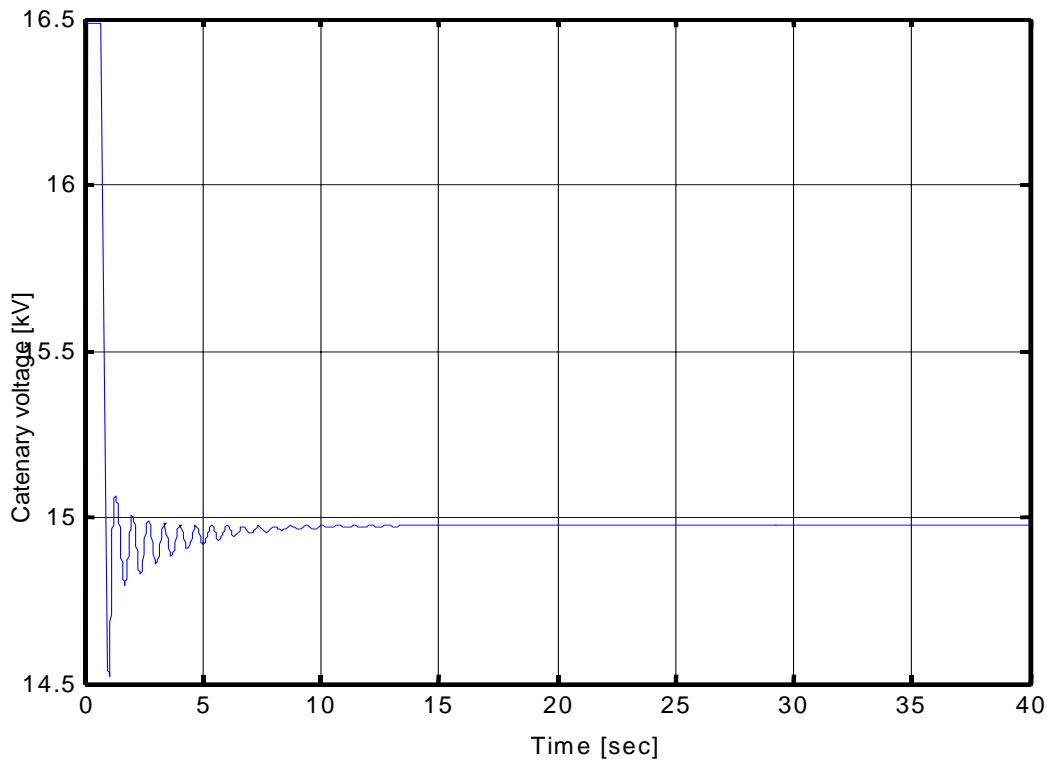

Figure A5-2 U 60km for active power step in the train of 0 – 2.0 MW

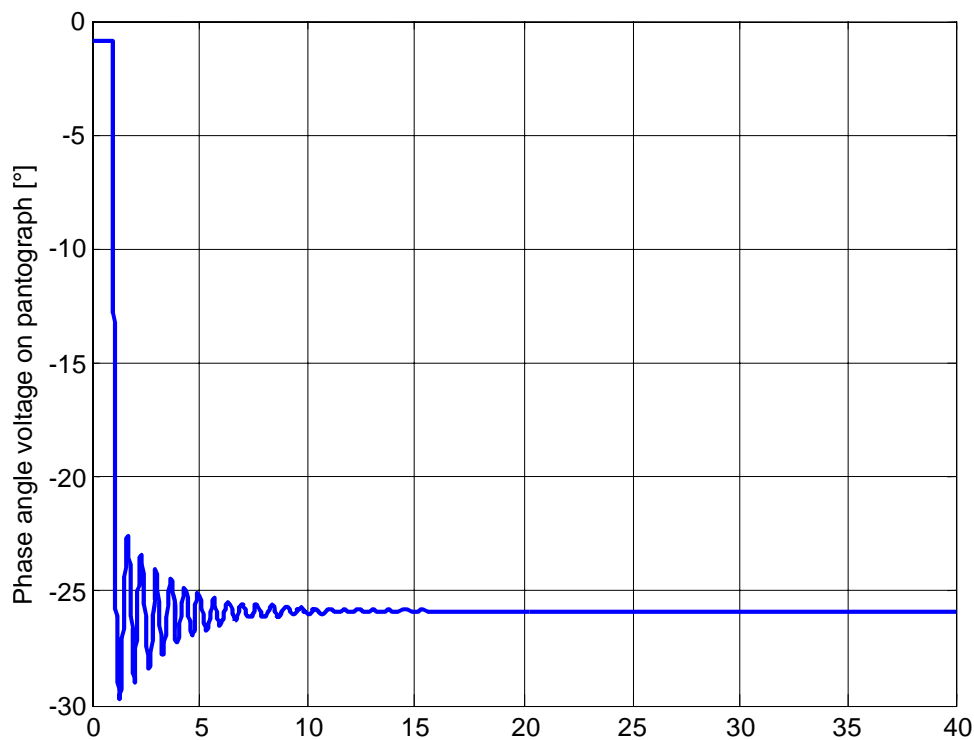

Figure A5-3 PA 60km for active power step in the train of 0 – 2.0 MW

Maximum oscillation (top – bottom) varies with the power step size as follows:

Power step in train	Max. oscillation	
	U 60km	PA 60 km
0 – 3.50 MW	≈ 690 V	≈ 13°
0 – 2.00 MW	≈ 270 V (Shown in Figure A5-2)	≈ 7° (Shown in Figure A5-3)
0 – 0.25 MW	≈25 V	

Comments:

- Sudden step changes in active power cause heavy oscillation in the converter rotor position (pole angle).
- Even small power steps cause noticeable oscillation.
- Whether the power step is caused by load decrease or load increase has little significance for the oscillation’s magnitude.

A5.2.5 Active power ramp response

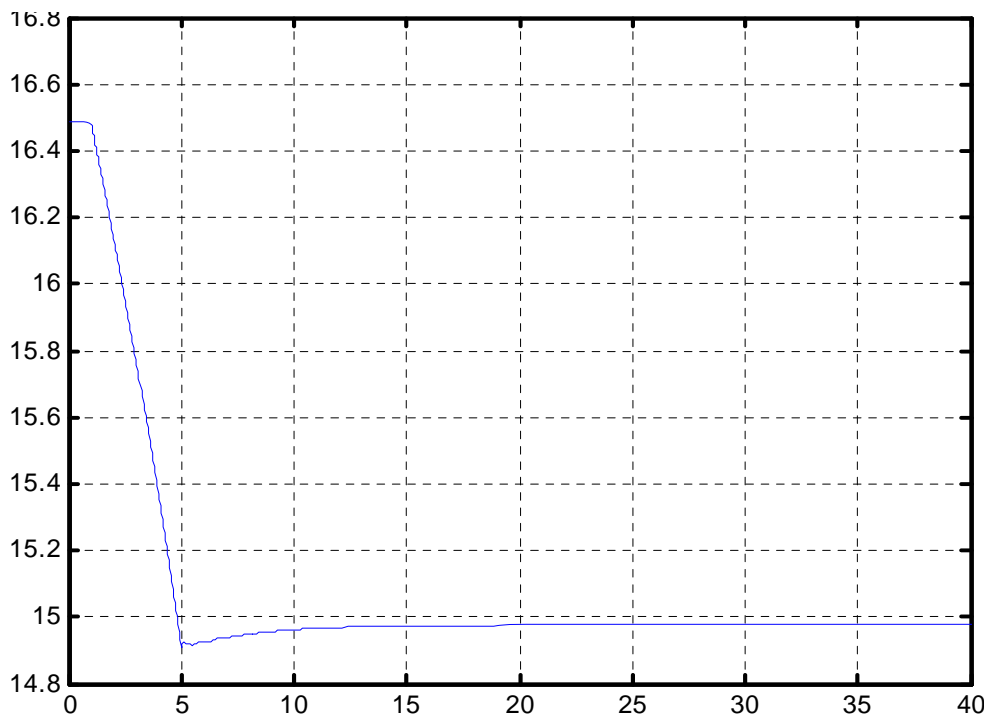

Figure A5-4 U 60km for increased power 0 -2.0 MW for linear steepness of 0.5 MW/s

Maximum oscillation (top – bottom) varies with the power step (ramp) steepness as follows:

Power change in the train 0 – 2.0MW	Max. oscillation U 60km
Step	270 V (Shown in Figure A5-2)
1,5 MW/s linear steepness	14 V
0,5 MW/s linear steepness	5 V (Shown in Figure A5-4)

Comment:

- The oscillation magnitude due to change in active power decreases significantly when the power change take place as a ramp of limited steepness. Whether the oscillation is caused by load decrease or load increase has little significance for the oscillation's magnitude.

A5.2.6 Repetitive changes in active power

Figure A5-5 shows U 60km for a train that in the beginning consume 4.0 MW and then an unsymmetrical saw-tooth shaped change in load with maximum unfavourable frequency (1.6 Hz) and flank steepness of -1.5 MW/s and + 0.5 MW/s respectively. Repeating power change in each saw-tooth period is 234.375 kW with 4.0 MW as maximum power.

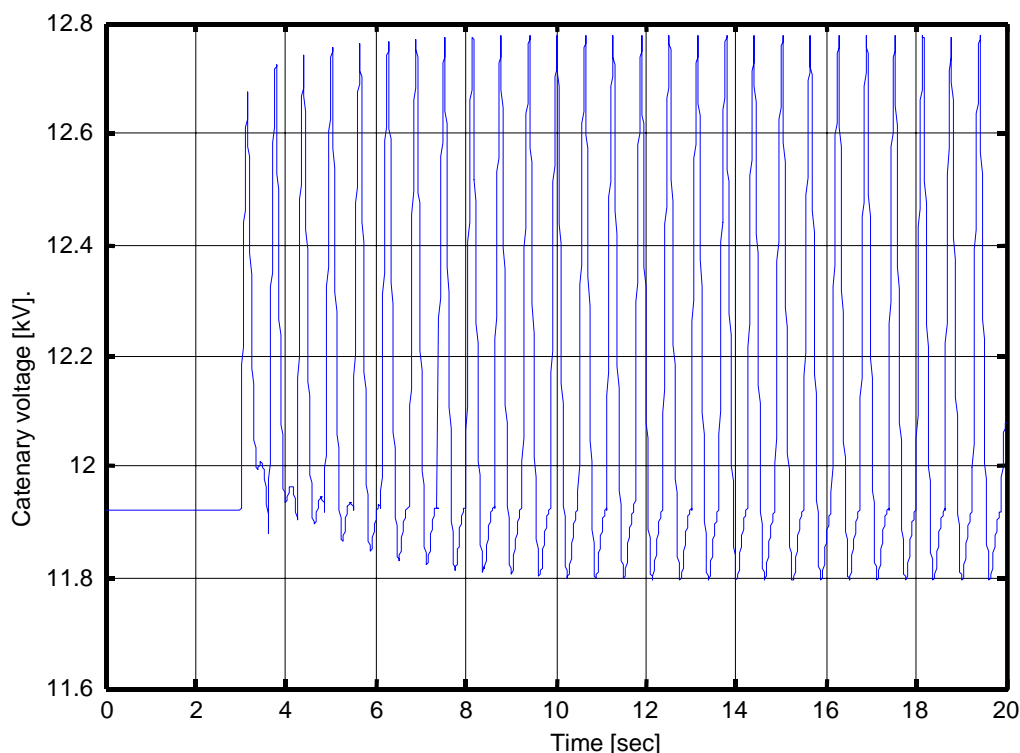

Figure A5-5

Maximum oscillation in contact line voltage (top – bottom) is as follows:

Periodic power change 1.6 Hz:	Max. oscillation U 60km
234.375 kW	990 V (Shown in Figure A5-5)

Comparatively, a repetitive symmetric load change having the same change in each saw-tooth will have flank steepness of +0.75 MW/s and -0.75 MW/s and cause about 5 % larger oscillation in the contact line voltage.

Comment:

- Even small power changes will after a few oscillation periods cause considerable oscillation if they are repeated at an unfavourable frequency. If being able to allow rapid repeating power changes in one power direction (e.g. power reduction when activating

wheel skid or glide protection) is technically desirable, the converter rotor oscillation can to some extent be limited by implementing stricter restrictions for power changes in the opposite direction.

A5.2.7 Reactive power step response

Figure A5-6 shows U 60km for a converter having 2.0 MW preload and voltage independent load for steps of 0 – 1.0 MVar inductive power.

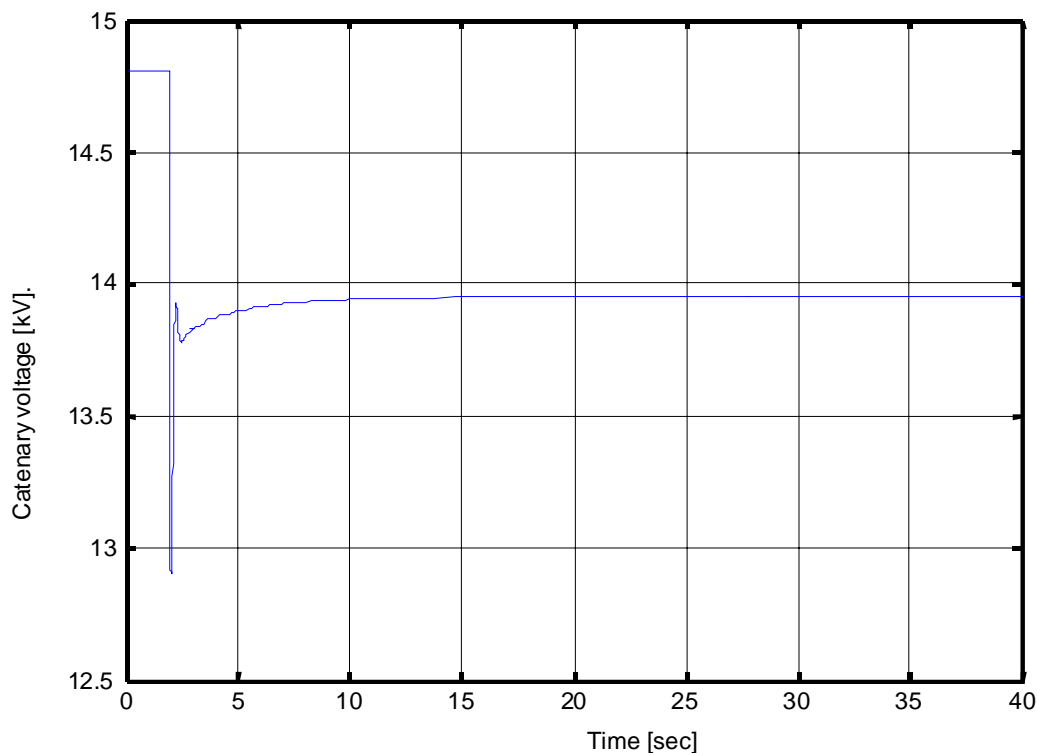

Figure A5-6

Maximum deviation in contact line voltage will be:

Reactive power step:	Transient reduction U 60km
0 - 1,0 Mvar	ca. 1000 V (Shown in Figure A5-6)

Comment:

- Steps in reactive power in themselves cause only marginal oscillation in the converter unit's pole angle. However, due to converter unit and contact line inductance, a big initial contact line voltage variation occurs. Indirectly, steps in reactive power may cause some oscillation due to the resulting changes to active losses in the system.

Step reductions of reactive power will also cause brief powerful variations in contact line voltage, but causing the voltage to rise rather than drop.

A5.3 Voltage phase angle variation with load

During increasing load the converter units' power angle and thus the phase angle for generated single-phase voltage decreases considerably relative the voltage in the 50 Hz grid. The 1-phase phase shift relative to the 50 Hz grid can be calculated as:

$$\Psi = \Psi_0 + \Psi_{\text{conv}} \quad \text{where}$$

Ψ_0 = angle difference between the 50 Hz and 16.7 Hz at no load on the converter and

$$\Psi_{\text{conv}} = - \left[\frac{1}{3} \arctan(x_{qM} \cdot i_G \cdot \cos \varphi_G) + \arctan\left(\frac{x_{qG} \cdot i_G \cdot \cos \varphi_G}{1 + x_{qG} \cdot i_G \cdot \sin \varphi_G}\right) \right]$$

where

x_{qM} is the converter motor quadrature-axis synchronous reactance in p.u.

x_{qG} is the converter generator quadrature-axis synchronous reactance in p.u., including the short circuit impedance of the transformer

i_G is the current of the converter generator in p.u. of rated current

$$i_G = I_G / I_{n_G}$$

I_G is the current of the converter generator [A]

I_{n_G} is the rated current of the converter generator [A]

φ_G is the phase shift between the current and voltage of the generator

In the equation the following assumptions are made:

- Both the 3-phase synchronous motor and the 1-phase synchronous generator are modelled as synchronous machines with salient poles.
- The 3-phase motor is not magnetized, i.e. $Q_{50} = 0$.
- The axle between the synchronous motor and 1-phase synchronous generator is stiff and has no losses.
- All losses in the motor and generator are neglected.

Figure A5-7, below, shows 1-phase phase lag for 10 MVA converter units. 5.8 MVA converter units have approximately 10 % larger phase lag for the same relative load. The figure is plotted for and inductive load when $\cos(\varphi) < 1$. In the figure Ψ_0 is set to zero.

As can be seen from the figure all lines goes through the origin. If the losses in the motor and generator were to be included there should be a death-band around the horizontal line $-\Psi=0$, i.e. positive active power would mean that the line would start from lag greater than zero and for negative active power the lines would start from a lag less than zero.

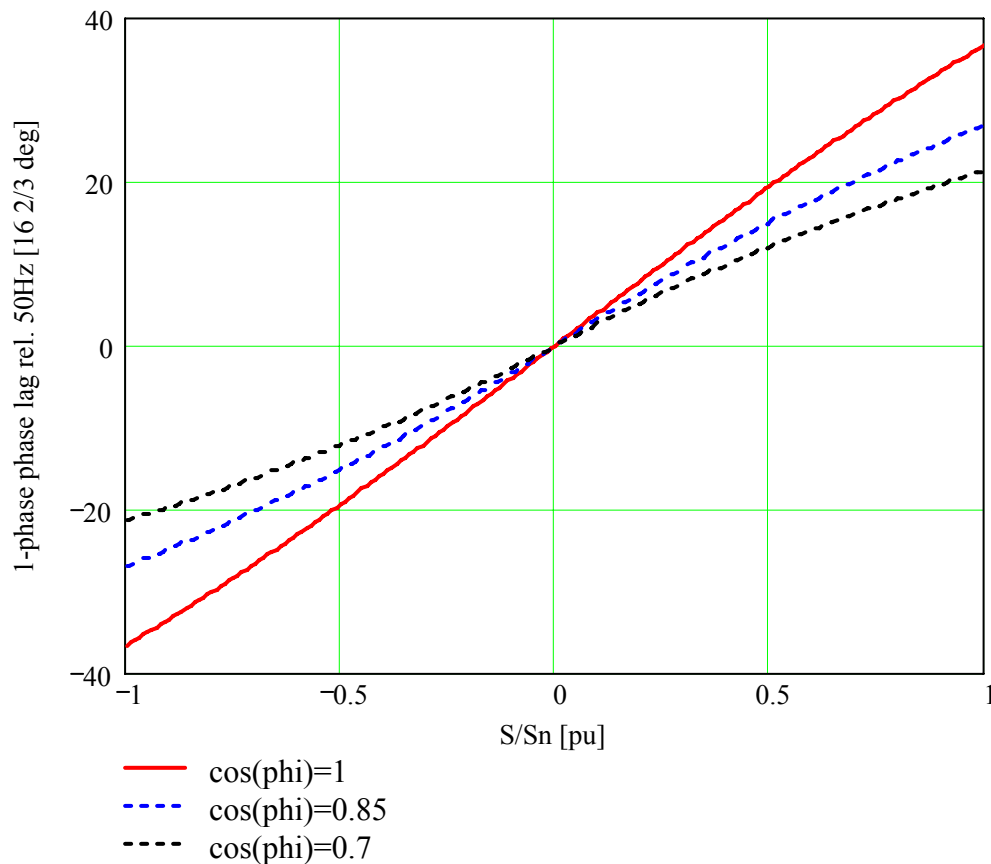

Figure A5-7 Phase angle lag single-phase voltage relative to 3-phase voltage for 10 MVA rotary converter units.

Note that the figure depicts the phase lag, not the phase shift. The angle lags more and more with increasing load. Note also that the figure is valid also for negative active power, i.e. when feeding from the 1-phase side to the 3-phase side, but only the active power is reversed. The reactive load is still the same, i.e. an inductive load at the 1-phase side which correspond to a electrical braking vehicle with $\cos(\phi)$ -control.

While the converter unit change power angle, the voltage's steepness change and the voltage zero crossing will be displaced, increasingly with the speed of change. By increasing the distance to the converter station, the voltage's phase will vary even more with the load due to the contact lines inductive impedance.

A5.4 Time domain Model

This chapter describes a simple time domain simulation model for rotating converters as they are in operation in the Norwegian and Swedish railway system. This model can be used by railway vehicle manufacturers for compatibility studies prior to first tests with new vehicles. The model is derived by emkamatik, document 06-0132. It is derived from more detailed models implemented by SINTEF Energy Research, Trondheim. The document includes some validation examples and an application guide on how to use the model.

The model is programmed in Matlab / Simulink and is available as a Simulink block on request.

A5.4.1 Physical background

The rotating frequency converters in Sweden and Norway consist of a 50-Hz synchronous motor directly coupled to a 16 2/3-Hz synchronous generator. They perform a frequency conversion by a factor of three and allow a power flow in both directions. The converters used in Sweden and Norway do not have damping windings on the rotor of the 50-Hz machine (3-phase side), therefore the corresponding eigenfrequency of the pole angle oscillation (between 1.6 and 1.8 Hz) is poorly damped (quality factors up to 10). Excessive oscillations of the rotor around its stationary pole angle can be produced by either strong or repetitive power variations of a train (e.g. adhesion control) or by feedback loop effects with the vehicle control in general. Negative effects of excessive converter oscillations include higher mechanical stress in the machines as well as significant periodic variations („flicker“) in weaker parts of the 50-Hz network.

Seen from a railway vehicle, the rotating converter shall be modelled as a „black box“ with the following main characteristics:

- Inner impedance of the generator. This also an RL impedance and is, therefore, not considered specially. In principal it has the same effect as a longer line.
- Voltage control, depending on the load. Normally, the output voltage is controlled to a nearly constant value, by means of variation of the excitation current of the machine.
- Pole angle variations. The angle of the induced voltage of a synchronous machine varies with the load current in the machine. The angle is lagging if load is drawn. For steady state operation, the relation between load current and angle follows a sine curve, but for small variations of the angle the behaviour can be linearised. Therefore, the generator reacts like a spring. Together with the rotating mass of the generator an oscillating system of 2nd order is formed. The following small figure shows a sketch of the spring – mass system formed by the rotating converter.

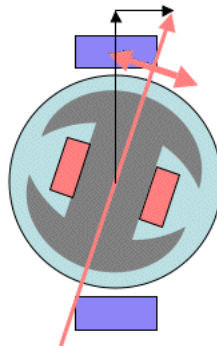

For all following considerations, the converter is always treated as a whole, not making any difference between 50-Hz and 16 2/3-Hz machine.

A5.4.2 Model structure

Chapter A5.2 contains the description of the behaviour of a rotating 5.8-MVA converter which is widely used in Norway and Sweden and a number of active and reactive load step and ramp responses. The task of the simulation model is to reproduce the shown behaviour in a “black box” manner, i.e. the reaction of the converter is just modelled as transfer functions while the motor and generator are not modelled as electrical circuits and controllers.

The figure below shows the simplified model of the rotating converter as a Matlab / Simulink model. It contains the following functional units:

- The model contains one output, the generator voltage U_{Gen} . It is calculated by the following expression:

$$U_{Gen}(t) = A(t) \cdot \sin(2\pi f_N t + \varphi(t))$$

where

- $f_N = 16\frac{2}{3} Hz$ is the nominal line frequency,
- $A(t)$ the amplitude and
- $\varphi(t)$ the pole angle.

Both amplitude and pole angle depend on the active and reactive power. The corresponding functional simulation blocks are marked with yellow background colour.

- The electric power delivered by the generator is calculated as

$$p(t) = U_{Gen}(t) \cdot I_{Line}(t), \quad \text{where } I_{Line}(t) \text{ is the line current.}$$

The active power $P(t)$ is calculated as the mean value of $p(t)$ over one fundamental line period

$$P(t) = \frac{1}{T} \int_{t-T}^t U_{Gen}(\tau) \cdot I_{Line}(\tau) d\tau.$$

The reactive power $Q(t)$ is calculated as

$$Q(t) = \frac{1}{T} \int_{t-T}^t U_{Gen}^*(\tau) \cdot I_{Line}(\tau) d\tau, \text{ where}$$

$U_{Gen}^*(t) = A(t) \cdot \cos(2\pi f_N t + \varphi(t))$ is the 90° phase shifted generator output voltage. The simulation blocks which calculate $P(t)$ and $Q(t)$ are marked with light green background colour.

The functions for the generator voltage's **phase** $\varphi(t)$ and **amplitude** $A(t)$ describe the dynamics of the generator and are conveniently formulated in the s domain (see also structure figure below).

▪ **Phase angle function:**

In the simplified model, the phase angle $\varphi(t)$ depends only on the active power $P(t)$:

$\varphi(s) = [G_0(s) + k(P) \cdot G_1(s)] \cdot P(s)$ where $P(s)$ is the laplace transformed time domain signal $P(t)$.

$G_0(s) = \frac{A_0}{T_0^2 s^2 + 2d_0 T_0 s + 1}$ is an “oscillation component”.

$G_1(s) = \frac{A_1}{T_1 s + 1}$ is a “static component”, which is combined with

$k(P) = \varphi_0 + k_\varphi \cdot P$ the load depending gain $k(P)$, which approximates the nonlinear load – pole angle characteristics of the generator (hidden in the block “F1” below).

▪ **Amplitude function:**

In the simplified model, the amplitude $A(t)$ depends on active and reactive power:

$A(s) = U_N + [G_2(s) + G_3(s) + G_4(s)] \cdot P(s) + [G_5(s) + G_6(s)] \cdot Q(s)$

$U_N = \sqrt{2} \cdot 16.5 kV$ is the nominal line voltage amplitude,

$G_2(s) = \frac{A_2}{T_0^2 s^2 + 2d_0 T_0 s + 1}$ is an “oscillation component” (same denominator as

$G_0(s)$)

$G_i(s) = \frac{A_i}{T_i s + 1}$ with $i = 3 \dots 6$ represent transient effects.

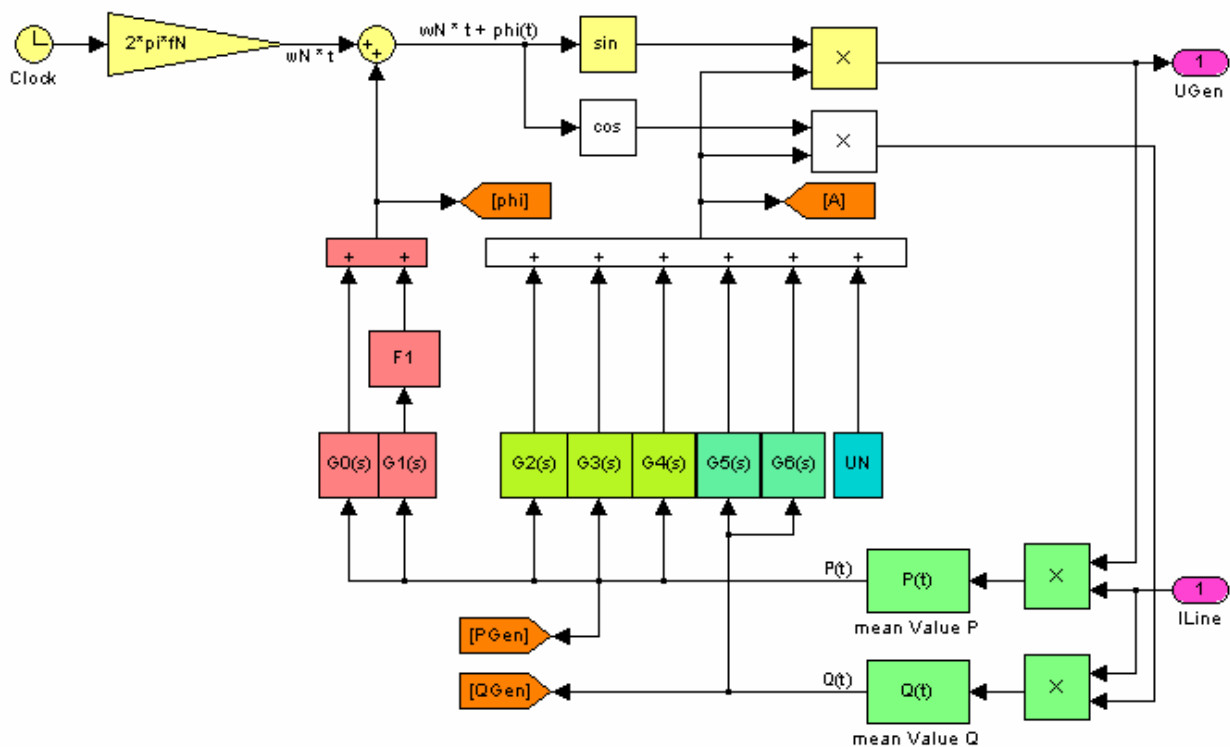

A5.4.3 Model parameters

The following parameter sets have been determined and allow the reproduction of the step responses shown in chapter A5.2 and in Norwegian National Rail Administration: Characteristics of infrastructure, Energy. Document JD 590, Chapter 4b. Issue 01.02.2005, with good accuracy:

- Case 1 1 x Q38, weak 3-phase network (Norway minimum 70 MVA)
- Case 2 1 x Q38, strong 3-phase network (Sweden typical 2500 MVA)
- Case 3 1 x Q 48, strong 3-phase network (Sweden typical 2500 MVA)

	Q 38 weak 3-phase network	Q 38 strong 3-phase network	Q 48 weak 3-phase network
A_0	$-12.25^\circ / 5.8 MVA$ $= -3.6863 \cdot 10^{-8} \text{ rad/VA}$	same as Q38 weak	$= -1.8431 \cdot 10^{-8} \text{ rad/VA}$
T_0	$\frac{1}{2\pi \cdot 1.5\text{Hz}} = 0.1061\text{s}$	$\frac{1}{2\pi \cdot 1.6\text{Hz}} = 0.0995\text{s}$	$\frac{1}{2\pi \cdot 1.9\text{Hz}} = 0.0838\text{s}$
D_0	0.045	0.055	0.055
A_1	1	same as Q38 weak	1
T_1	0.05s	same as Q38 weak	same as Q38 weak
φ_0	$-1.3541 \cdot 10^{-7}$	same as Q38 weak	$-6.7707 \cdot 10^{-8}$
k_φ	$5.1586 \cdot 10^{-15}$	same as Q38 weak	$2.5793 \cdot 10^{-15}$
A_2	$1 \cdot 10^{-4} \text{ V/W}$	same as Q38 weak	$0.5 \cdot 10^{-4} \text{ V/W}$
A_3	$-2.0 \cdot 10^{-4}$	same as Q38 weak	$-0.8 \cdot 10^{-4}$
T_3	0.05s	same as Q38 weak	same as Q38 weak
A_4	$1.0 \cdot 10^{-4}$	same as Q38 weak	$0.4 \cdot 10^{-4}$
T_4	2.0s	same as Q38 weak	3.0s
A_5	$-1.5 \cdot 10^{-3}$	same as Q38 weak	same as Q38 weak
T_5	0.25s	same as Q38 weak	same as Q38 weak
A_6	$1.5 \cdot 10^{-3}$	same as Q38 weak	same as Q38 weak
T_6	0.001s	same as Q38 weak	same as Q38 weak

A5.4.4 Line parameters

To create a complete power supply model a line impedance has to be added between the models of converter and train (see below). Typical values can be taken from section A1.5.9. For the investigation of realistic cases of low frequency behaviour the following values can be taken:

- $Z_{Line,km} = 0.18 + j 0.19 \Omega/km$
- The line of 60 km, which gives a line impedance of $Z_{Line} = 10.8 + j 11.4 \Omega$.

The resulting model is then comparable to the situation in Gjøvik, a single-side fed line in Norway, which has been taken already several times to test the behaviour of new trains.

A5.4.5 Simulations with vehicles

The operation of railway vehicles in networks with high line impedance can lead to low frequent power oscillations. The risk of such oscillations is reduced significantly if the vehicle controllers are tuned and verified with time domain simulations.

The simulation model as described above contains a simplified, however appropriate model of the power supply infrastructure. This model can now be combined with a detailed model of the vehicle including its control systems. The motor circuits and control shall be included in the vehicle model.

For the integration of a single vehicle the line impedance must be combined with the vehicle transformer short circuit impedance as shown below. The reason is that the current through the line and transformer inductance are equal and must be treated as one state variable in the simulation model. The pantograph voltage U_{Panto} can be calculated easily (Z_{Line} and Z_{Tr} form a voltage divisor).

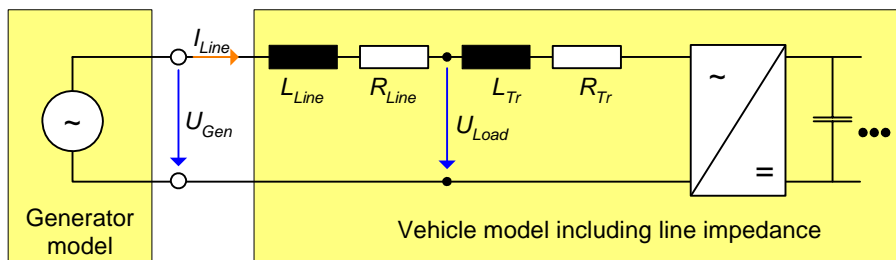

A5.4.6 Simulation of several vehicles

For the situation with more than one traction chain or several vehicles, it is normally still sufficient to simulate only one vehicle. This saves a lot of simulation time. It is assumed, that all vehicles are fed by the same catenary voltage and behave identically. This is a simplification, but yields good results as long as interactions between vehicles and the power supply system are investigated.

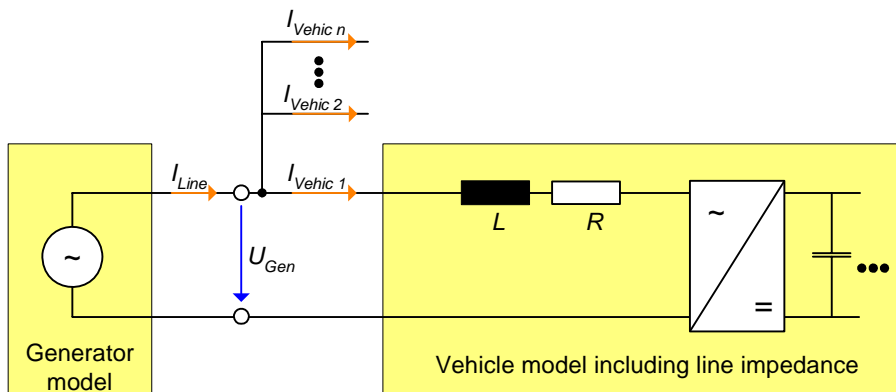

For this case the parameters of the converter and line model are scaled as follows:

As the voltage drop along the line depends on the number of simulated vehicles, the combined line and transformer impedance is now calculated with the following values:

$$R = R_{Tr} + n \cdot R_{Line}$$

$$L = L_{Tr} + n \cdot L_{Line}$$

n is the number of simulated vehicles, R_{Line} , L_{Line} , R_{Tr} and L_{Tr} are the same as above.

The generator current I_{Line} is equal to the sum of all vehicle line currents:

$$I_{Line} = n \cdot I_{Vehicle}$$

A5.4.7 Validation examples

The simulation model shown in this chapter, A5.4, has been tested and compared both for an RL load and with a detailed simulation model of an existing train. Each simulation is documented with the following signals:

- Upper left plot: active and reactive power at generator (P_{Gen} , Q_{Gen})
- Lower left plot: active and reactive power at line end (P_{60km} , Q_{60km})
- Upper right plot: line voltage at line end (U_{60km})
- Lower right plot: phase angle of voltage at line end (PA_{60km}).
 PA_{60km} is the sum of the generators load angle and the phase shift caused by the line impedance and ist measured relative the d axle. The d axle represents the phase angle of the generator for the no load situation.

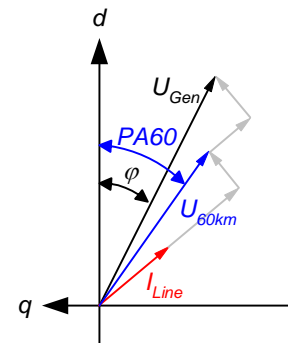

A5.4.7.1 Simulation with RL load

The following plots show the reaction of a 2.0-MW active power load step, and the comparison with the SIMPOW simulations shown in Norwegian National Rail Administration: Characteristics of infrastructure, Energy. Document JD 590, Chapter 4b. Issue 01.02.2005.

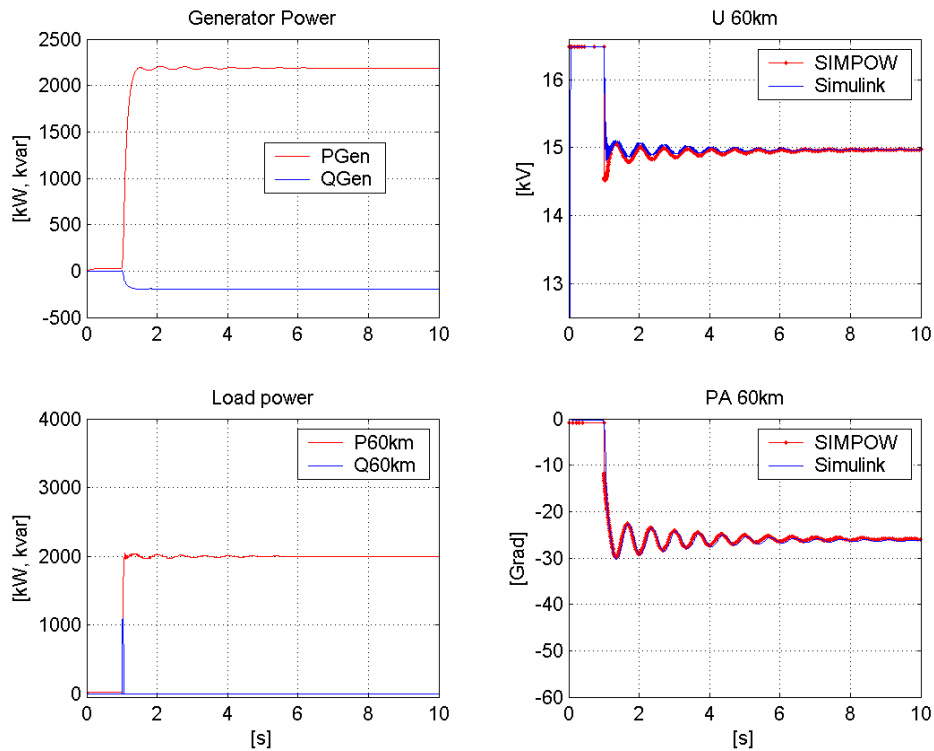

A5.4.7.2 Simulation with a vehicle

The simulation model contains one converter of type Q38 / Q39 and a 60 km long line. The structure and parameter of the vehicle model represents a modern EMU with two inverter traction units, being present in the system in a certain number.

The first 9 seconds containing the initialisation of the simulation model are not shown. At t = 10 seconds, the motor power of the vehicle is slightly increased in a stepwise manner to excite the system. The increase of active power is clearly visible at the generator. The catenary voltage U60km and its phase angle show short transients with the quite well damped 1.5-Hz oscillation.

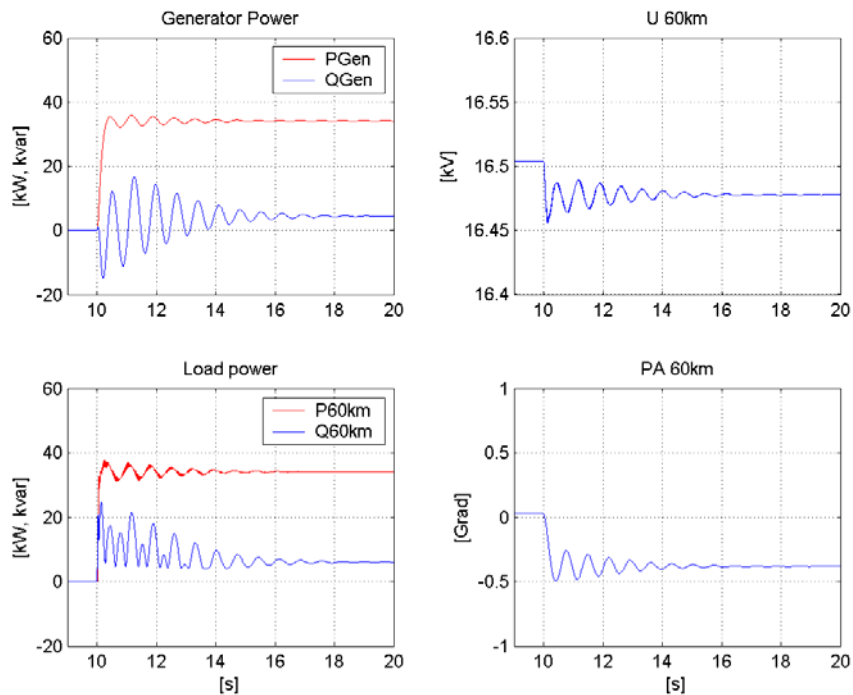

In the situation with twice the number of vehicles the 1.5-Hz oscillation is increasing and the situation unstable:

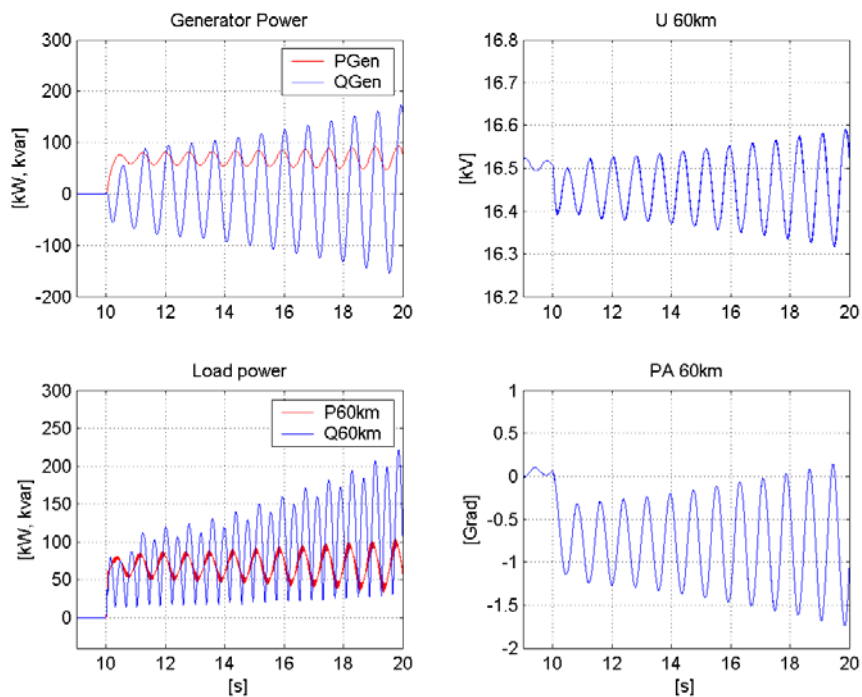

A5.4.8 Application of the model

When applying the converter model for compatibility studies, the following items shall be considered:

- The model shall help to evaluate and optimise the control structure and parameters of the inverter and traction control of electrical rail vehicles. Therefore, the simulations shall be done for various configurations of power supply and vehicle models. It must be the goal to reach a robust controller design rather than a sophisticated optimisation for one case derived from this simplified converter model.
- Typical numbers of converters are one to three, typical numbers of vehicles one to about five. A variation and combination of these numbers shall be performed until the stability limit can be derived. However, not all combinations will allow a realistic simulation for all operation points of the vehicle Example: one converter plus the maximum number of vehicles at full power and longest line length will not be a realistic case.
- Typical line lengths are between 10 and about 60 km. A line length of less than 5 to 10 km is not realistic, since in the model configuration the line impedance contains also the internal impedance of the synchronous generator.
- The simulations shall be done for both strong and weak 50-Hz supply (defined by the respective set of model parameters).
- The parameters shall be varied also to change the eigenfrequency between 1.5 and 1.9 Hz.
- Various effects caused by different controller parts of the vehicle shall be checked, including:
 - Closed loop stability in steady state operation at zero power, half and full traction power, half and full braking power.
 - Operation under bad rail – wheel conditions with active adhesion control.
 - Line power limitation due to low or high pantograph voltage in traction and braking.

A5.5 Phasor domain model

Description and input data for a phasor model of a rotary converter including utility network can be handed over by Norwegian National Rail Administration on request.

A6 APPENDIX 6: TYPICAL CROSS SECTION OF A BOOSTER TRANSFORMER LINE IN SWEDEN

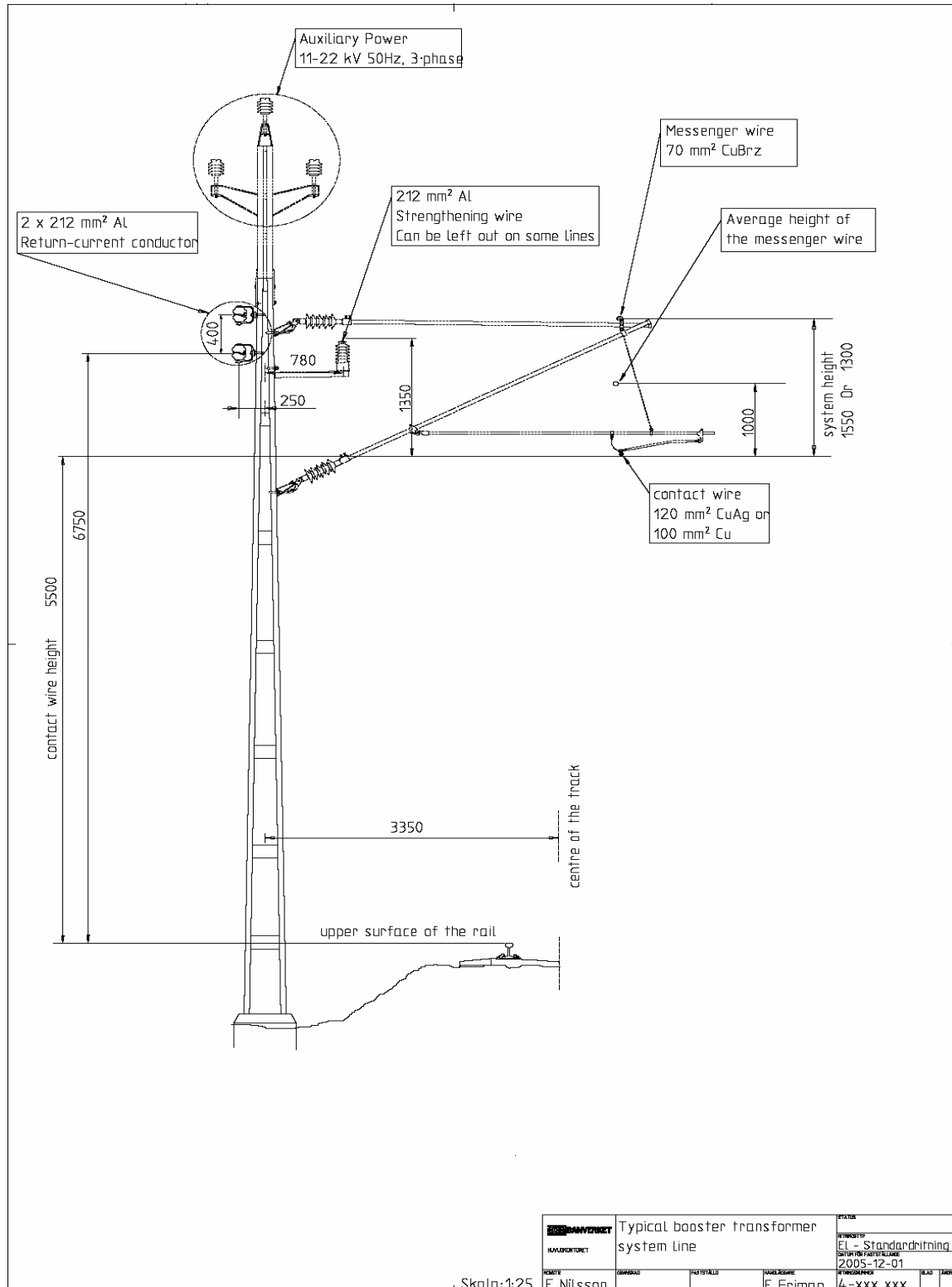

A7 APPENDIX 7: CROSS SECTION OF EXISTING AT-SYSTEM LINES IN SWEDEN

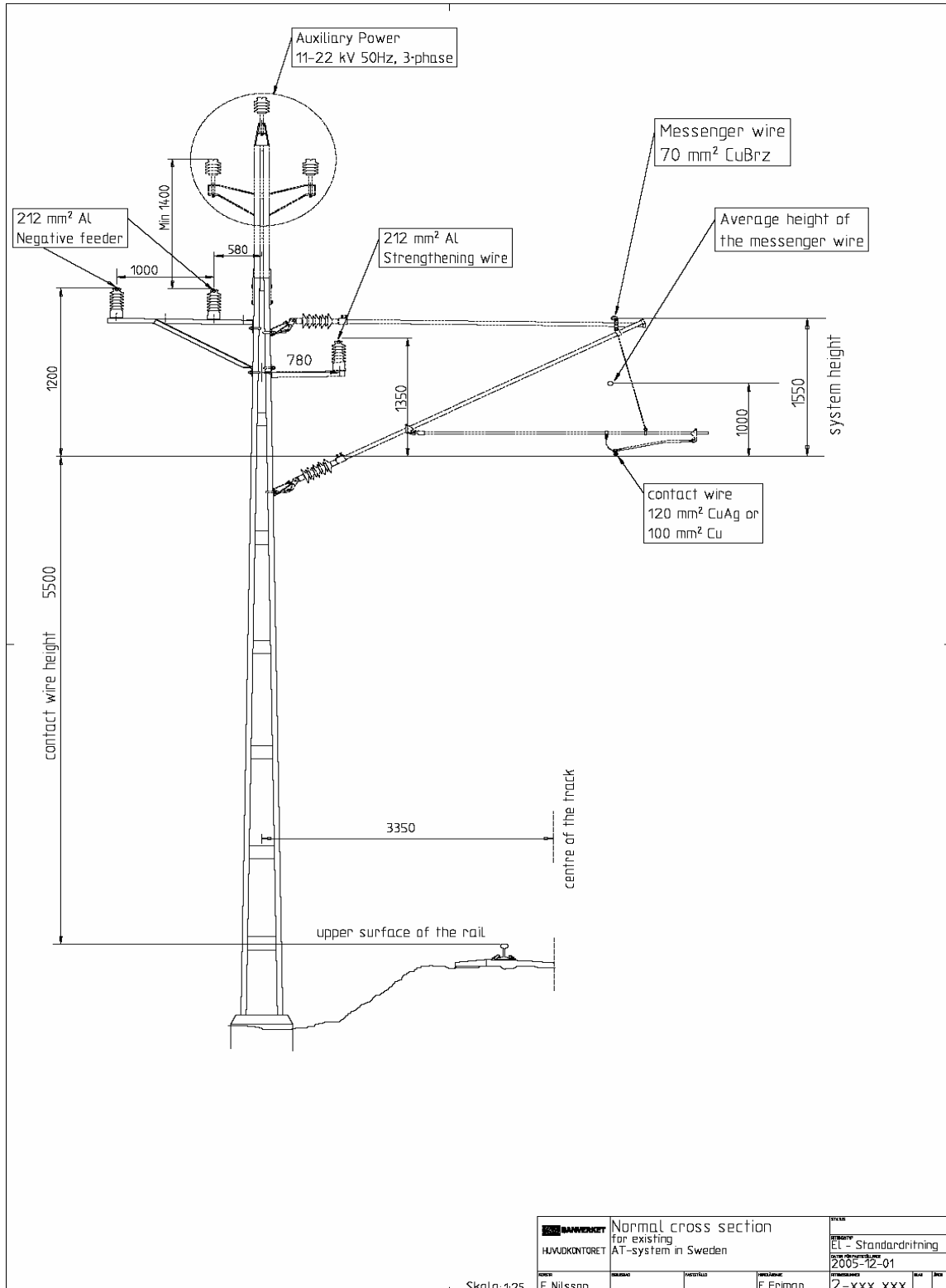

A8 APPENDIX 8: CROSS SECTION OF NEW STANDARD FOR AT-SYSTEMS LINES IN SWEDEN

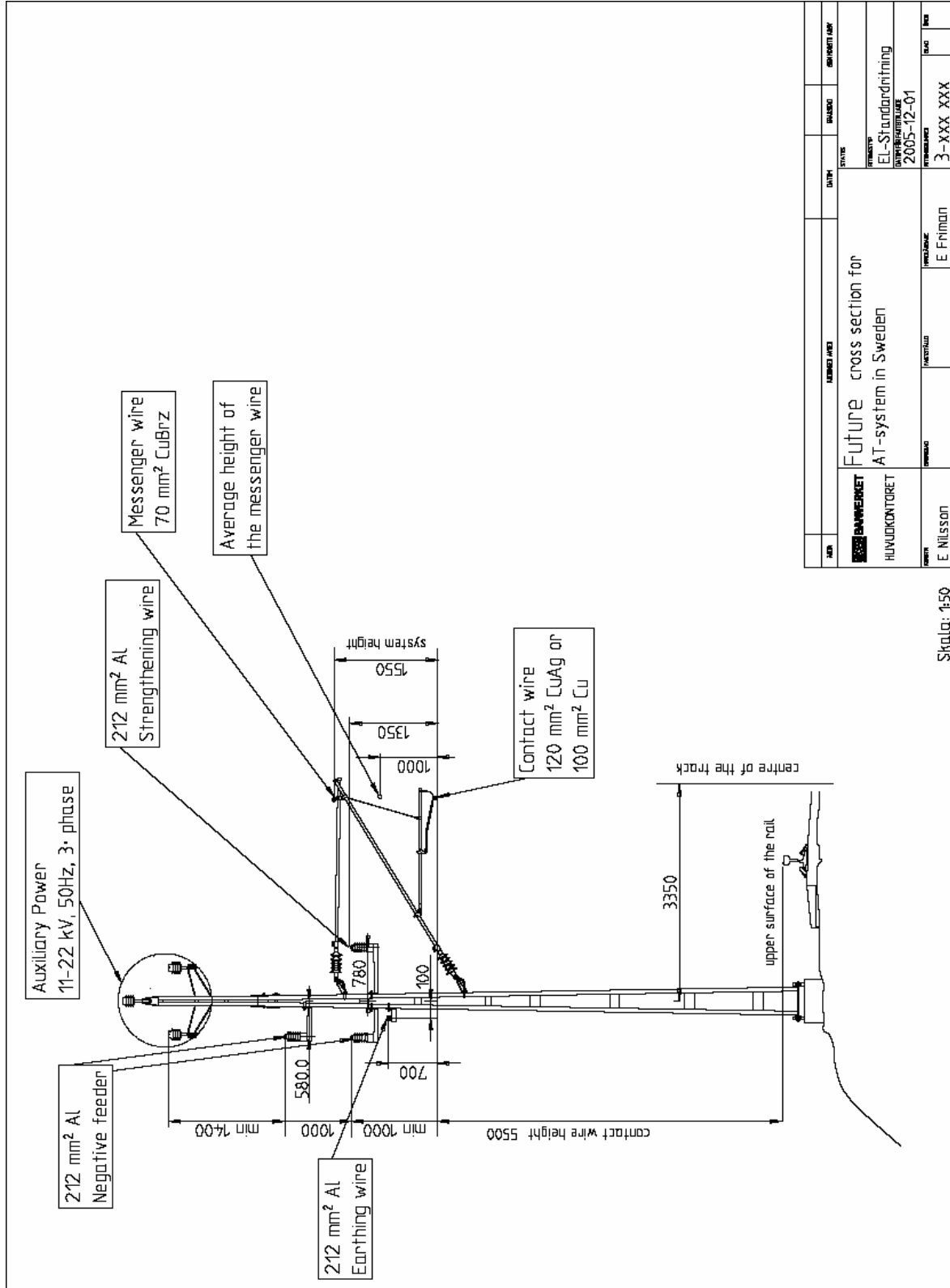

FAK	NUMMER/AVSÄT	DATUM	STATUS	REVISOR	REVISOR
HUVUDKONTORET	Future cross section for AT-system in Sweden		EL-Standardisering		
E. NILSSON			2005-12-01		
			3-XXX-XXX		

Skala: 1:50

A9 APPENDIX 9 : PSOPHOMETRIC WEIGHTING FACTORS ACCORDING TO ITU-T

Frequency [Hz]	Weighting factor, P_{fn}
16,66	0,056
50	0,71
100	6,91
150	35,5
200	89,1
250	178
300	295
350	376
400	484
450	582
500	661
550	733
600	794
650	851
700	902
750	955
800	1 000
850	1 035
900	1 072
950	1109
1 000	1 122
1 050	1 109
1 100	1 072
1 150	1 035
1 200	1 000
1 250	977
1 300	955
1 350	928
1 400	905
1 450	881
1 500	861
1 550	842
1 600	824
1 650	807
1 700	791
1 750	775
1 800	760
1 850	745
1 900	732
1 950	720
2 000	708
2 050	698

Frequency [Hz]	Weighting factor, P_{fn}
2 100	689
2 150	679
2 200	670
2 250	661
2 300	652
2 350	643
2 400	634
2 450	626
2 500	617
2 550	607
2 600	598
2 650	590
2 700	580
2 750	571
2 800	562
2 850	553
2 900	543
2 950	534
3 000	525
3 100	501
3 200	473
3 300	444
3 400	412
3 500	376
3 600	335
3 700	292
3 800	251
3 900	214
4 000	178
4 100	144,5
4 200	116
4 300	92,3
4 400	72,4
4 500	56,2
4 600	43,7
4 700	33,9
4 800	26,3
5 000	20,4
> 5 000	15,9
> 6 000	7,1