

1	UIC60 / PANDROL FASTCLIP / NSB 95.....	2
2	UIC60 / PANDROL e / NSB 93.....	3
3	S49/S54 / PANDROL FASTCLIP / JBV 97	4
4	S41/S49/S54 / PANDROL e / NSB 90.....	5
5	S41/S49/S54/PANDROL e / ENHETSSVILLE	6
6	S41/S49/S54 PANDROL PR / ENHETSSVILLE.....	7
7	35 kg/NSB40 / PANDROL PR / ENHETSSVILLE	8
8	NSB40/35 kg / PANDROL PR / ENHETSSVILLE SPESIAL	9
9	S41/S49/S54 / PANDROL PR / BETONGSVILLE 2.....	10
10	S41/S49/S54 / PANDROL PR / BETONGSVILLE 2 MED STØPEJERNSANKER.....	11
11	S41/S49 / HEY-BACK / BETONGSVILLE 2	12
12	S49/S54 / PANDROL E / TRESVILLER	13
13	S41/S49/S54 / HEY-BACK / TRESVILLER	14
14	35kg/NSB40 / HEY-BACK / TRESVILLER.....	15
15	UIC54/UIC60 / NABLA / TRESVILLER.....	16
16	S54/UIC54/UIC60/ DOBLE FJÆRSPIKER / TRESVILLER	17
17	UIC60 / PANDROL FASTCLIP/e-clip / BETONGSVILLE FOR SPORVEKSEL.....	18
18	S54/UIC60 / PANDROL PR / BETONGSVILLE FOR SPORVEKSEL.....	19
19	S49 / PANDROL PR / BETONGSVILLE FOR SPORVEKSEL.....	20

1 UIC60 / PANDROL FASTCLIP / NSB 95

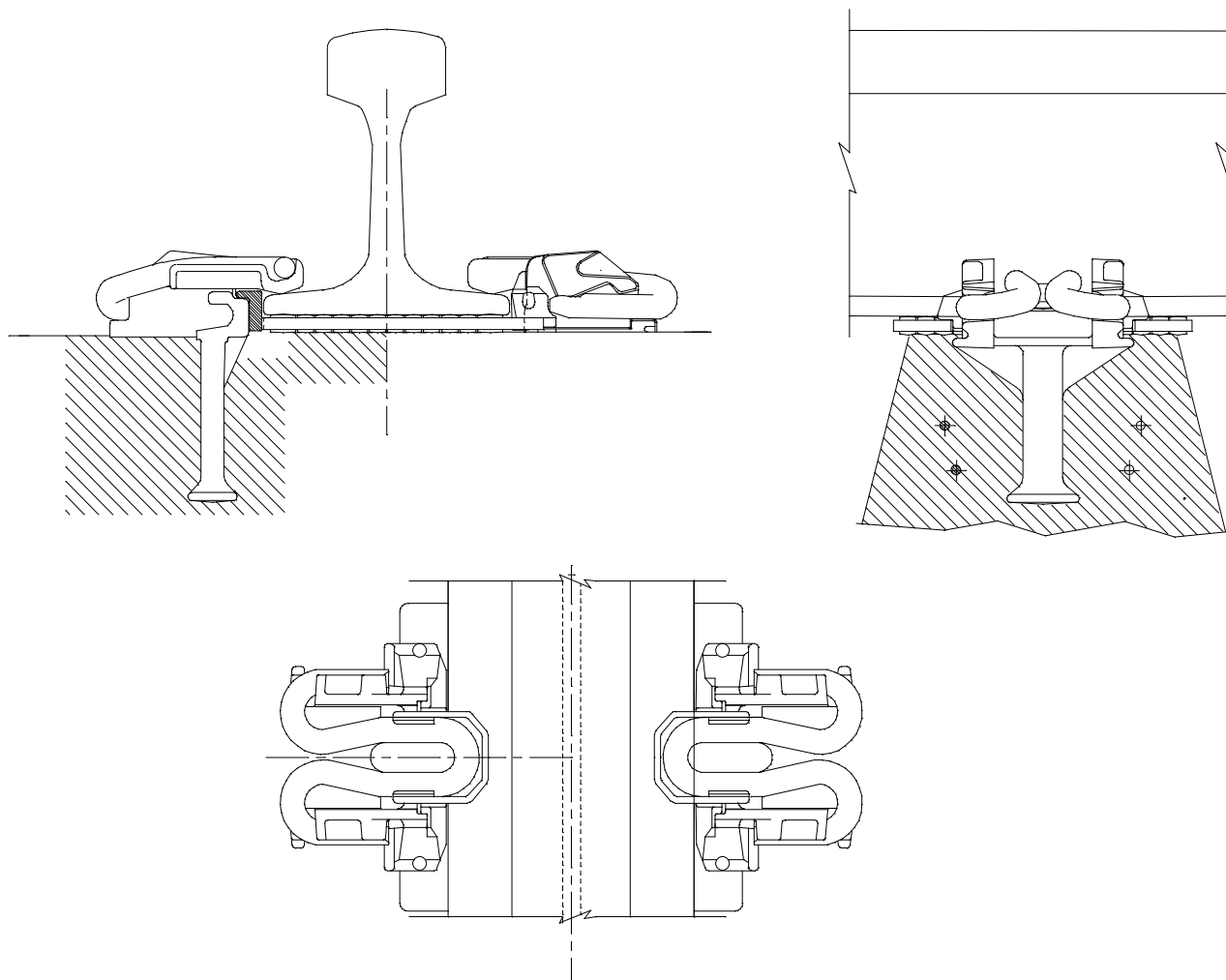

Tabell 6.a.1 Materialer til UIC60 / Pandrol Fastclip / NSB 95

Deler	Betegnelse	F.nr.	Ant. pr. sville
Skinner	UIC60	101.160.xx	-
Fjærer	Pandrol FC1501	103.203.01	4
Tåisolatorer	Sk 3162a	103.203.06	4
Sideisolatorer	Sk 3163	103.203.03	4
Mellomleggsplater (gummi)	Sk 3164	103.203.04	2
Sville	NSB 95	116.003.07 ¹⁾	-

¹⁾ NSB 95 sville med komplett Pandrol Fastclip befestigelse påmontert.

2 UIC60 / PANDROL e / NSB 93

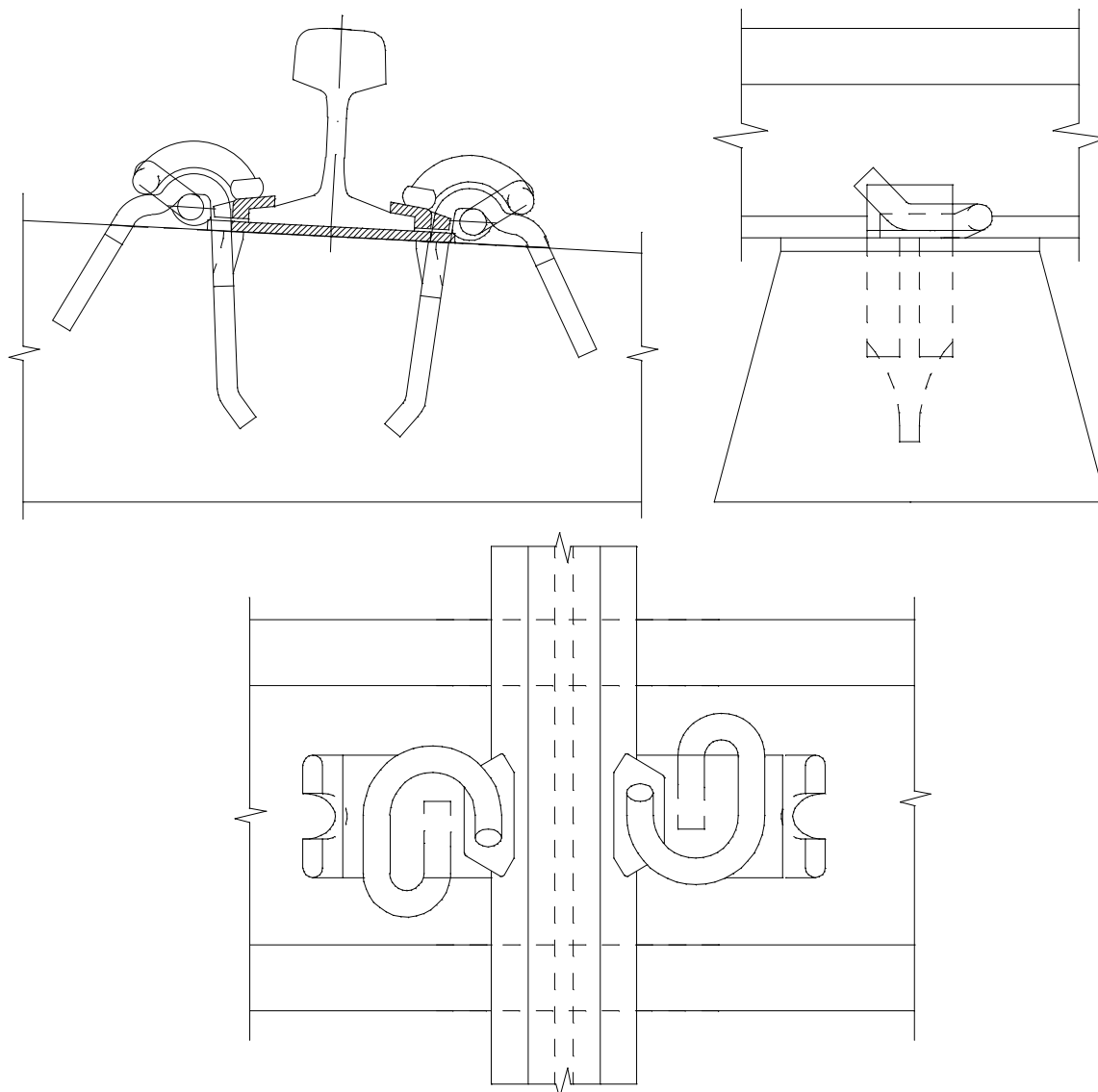

Tabell 6.a.2 Materialer til UIC60 / Pandrol e / NSB 93

Deler	Betegnelse	F.nr.	Ant. pr. sville
Skinner	UIC60	101.160.xx	-
Fjærer	Pandrol e1877	103.201.56	4
Isolatorer	Sk 3118	103.101.58	4
Mellomleggsplater (gummi)	Sk 3125	103.101.31	2
Sville	NSB 93	116.003.05	-

3 S49/S54 / PANDROL FASTCLIP / JBV 97

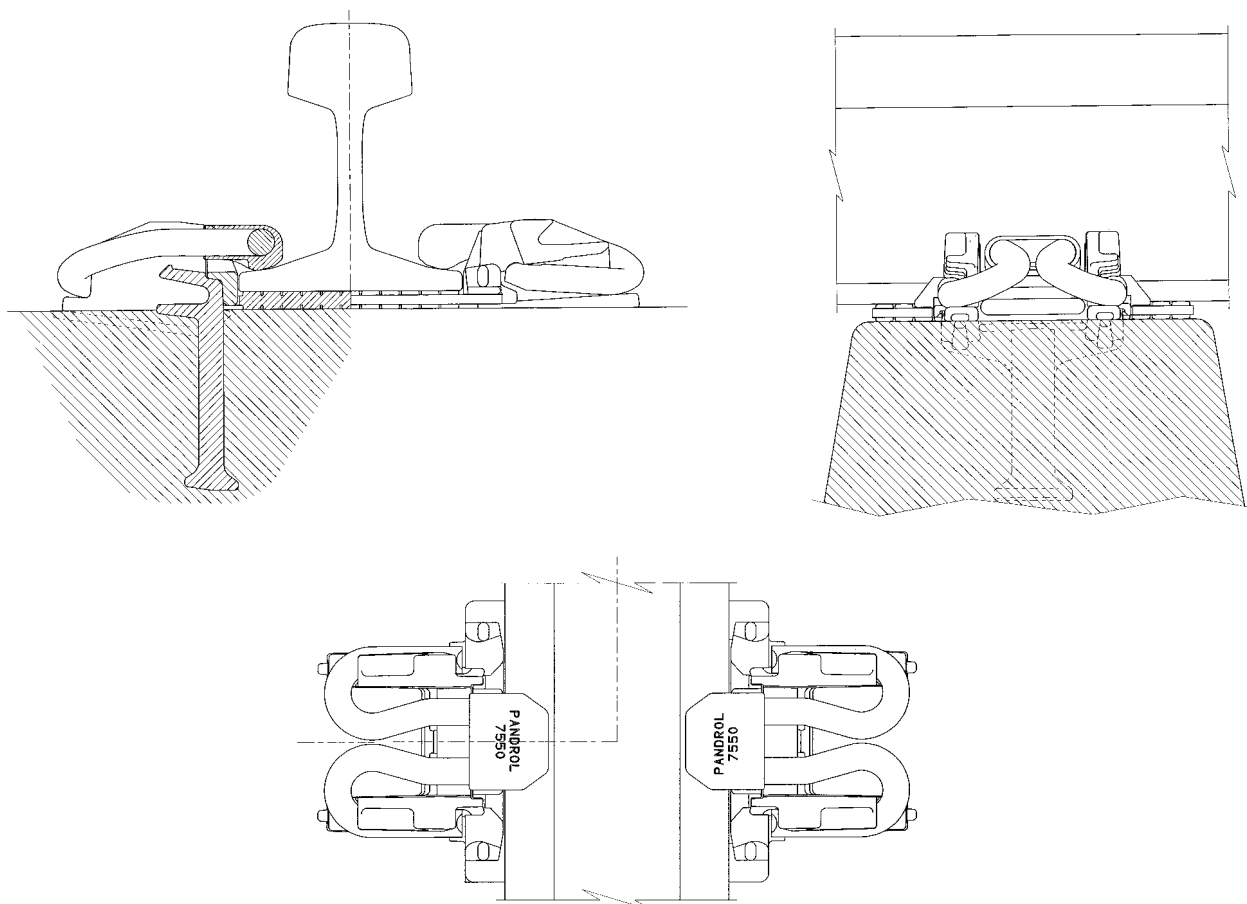

Tabell 6.a.3 Materialer til S49/S54 / Pandrol Fastclip / JBV 97

Deler	Betegnelse/F.nr.		Ant. pr. sville
Skinner	S49 101.149.xx	S54 101.154.xx	-
Fjærer	Pandrol FC1501 103.203.01	Pandrol FC1501 103.203.01	4
Tåisolatorer	Sk 3162a 103.203.06	Sk 3162a 103.203.06	4
Sideisolatorer	Sk 3163 103.203.03	Sk 3163 103.203.03	4
Mellomleggsplater (gummi)	Sk 3166 (10 mm) 103.203.05	Sk 3167 (10 mm) 103.203.05	2
Sville	JBV 97 116.003.04 ¹⁾	JBV 97 116.003.04 ¹⁾	-

¹⁾ JBV 97 sville med komplett Pandrol Fastclip befestigelse påmontert

4 S41/S49/S54 / PANDROL e / NSB 90

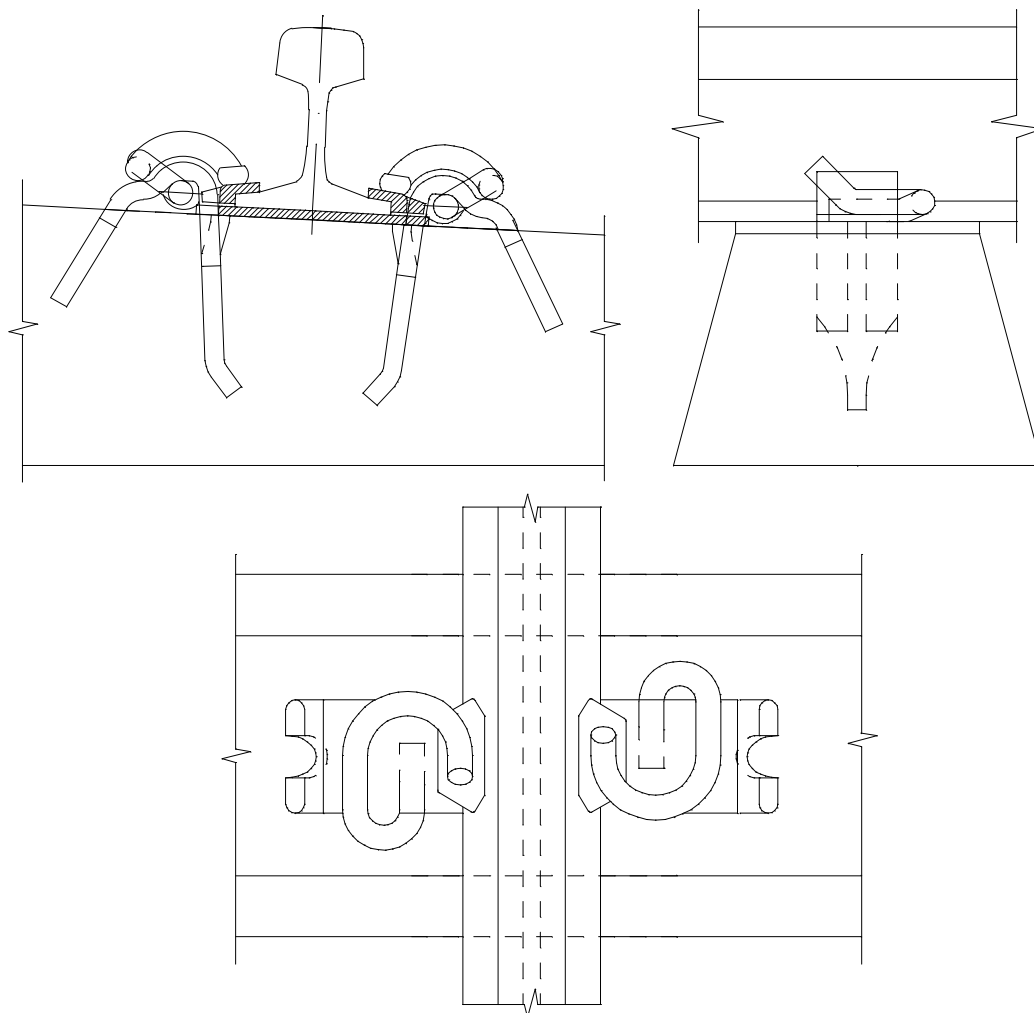

Tabell 6.a.4 Materialer til S41/S49/S54 / Pandrol e / NSB 90

Deler	Betegnelse / F.nr.			Antall / sville
Skinner	S41 101.141.xx	S49 101.149.xx	S54 101.154.xx	-
Fjærer	e1877 103.201.56	e1877 103.201.56	e1877 103.201.56	4
Isolatorer	Sk 3107 (rød) 103.101.55	Sk 3107 (rød) 103.101.55	Sk 3109 (blå) 103.101.57	4
Mellomleggsplate	Sk 3111 103.101.39	Sk 3111 103.101.39	Sk 3111 103.101.39	2
Sville	NSB 90 116.003.06	NSB 90 116.003.06	NSB 90 116.003.06	-

5 S41/S49/S54/PANDROL e / ENHETSSVILLE

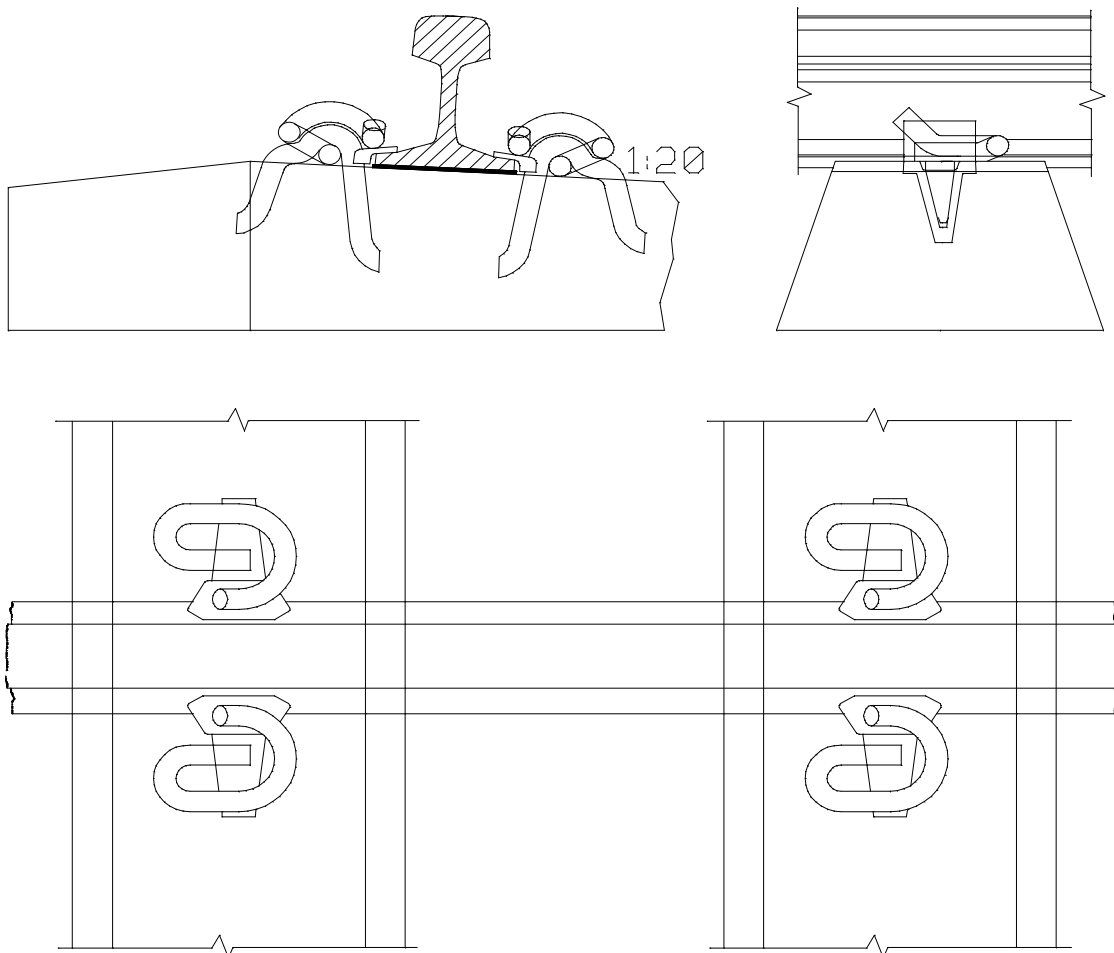

Tabell 6.a.5 Materialer til S41/S49/S54 / Pandrol e / Enhetssville

Deler	Betegnelse / F.nr.			Ant./sville
Skinner	S41 101.141.xx	S49 101.149.xx	S54 101.154.xx	-
Fjær	e1877 103.201.56	e1877 103.201.56	e1877 103.201.56	4
Mellomlegg	Sk 1632 103.101.33	Sk 1632 103.101.33	Sk 3169 103.101.28	2
Isolatorer	Sk 3101 (grå) 103.101.51	Sk 3101 (grå) 103.101.51	Sk 3103 (grønn) 103.101.53	4
Sviller	NSB enhetssville 116.003.01	NSB enhetssville 116.003.01	NSB enhetssville 116.003.01	-

6 S41/S49/S54 PANDROL PR / ENHETSSVILLE

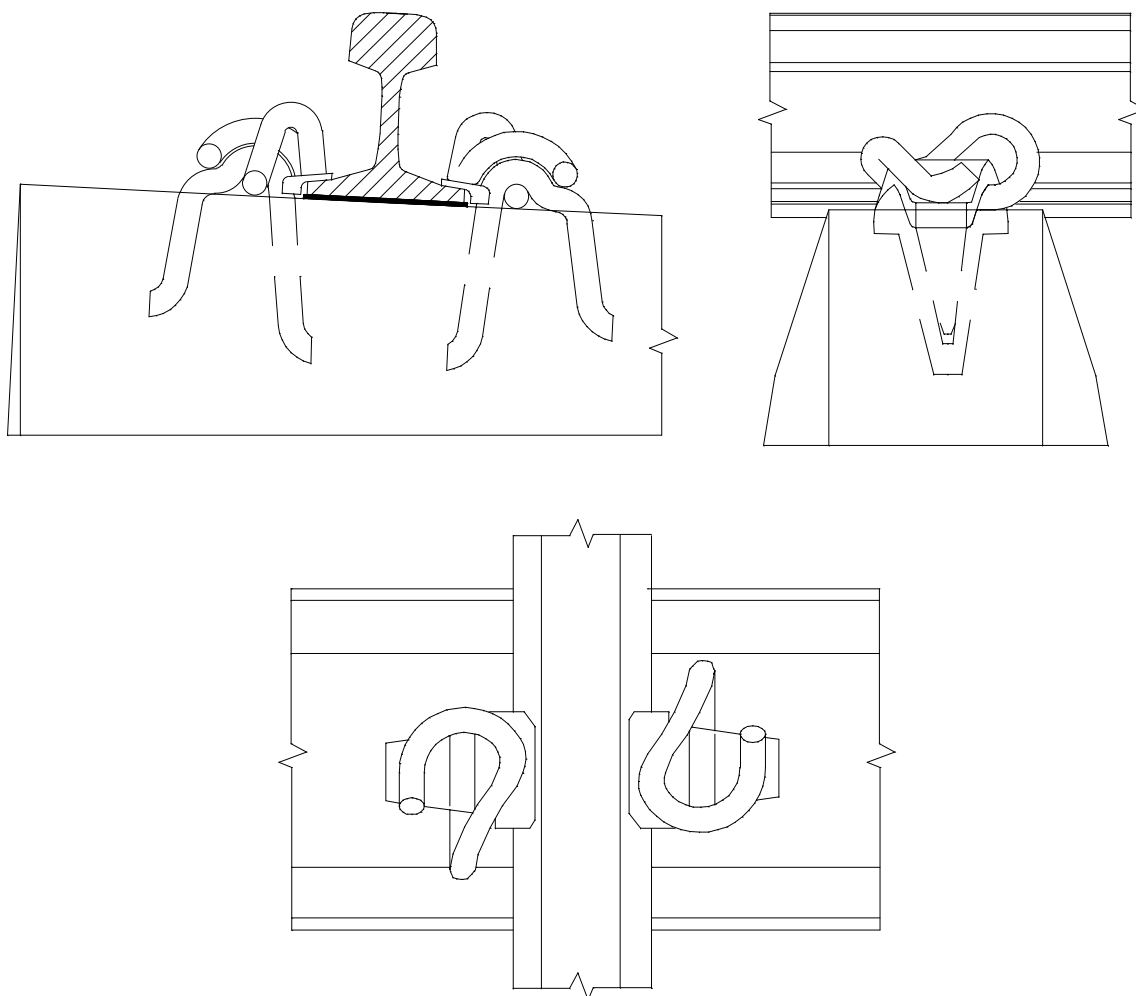

Tabell 6.a.6 Materialer til S41/S49/S54 Pandrol PR / Enhetssville

Deler	Betegnelse / F.nr.			Ant. / sville
Skinner	S41 101.141.xx	S49 101.149.xx	S54 101.154.xx	-
Fjærer	PR341 A (svart) 103.201.54	PR341A (svart) 103.201.54	PR341A (svart) 103.201.54	4
Mellomlegg	Sk 1632 103.101.33	Sk 1632 103.101.33	Sk 1632 103.101.33	2
Isolatorer	Sk 3117 (svart) 103.101.50	Sk 3117 (svart) 103.101.50	Sk 3117 (svart) 103.101.50	4
Sviller	NSB enhetssville 116.003.01	NSB enhetssville 116.003.01	NSB enhetssville 116.003.01	-

7

35 KG/NSB40 / PANDROL PR / ENHETSSVILLE

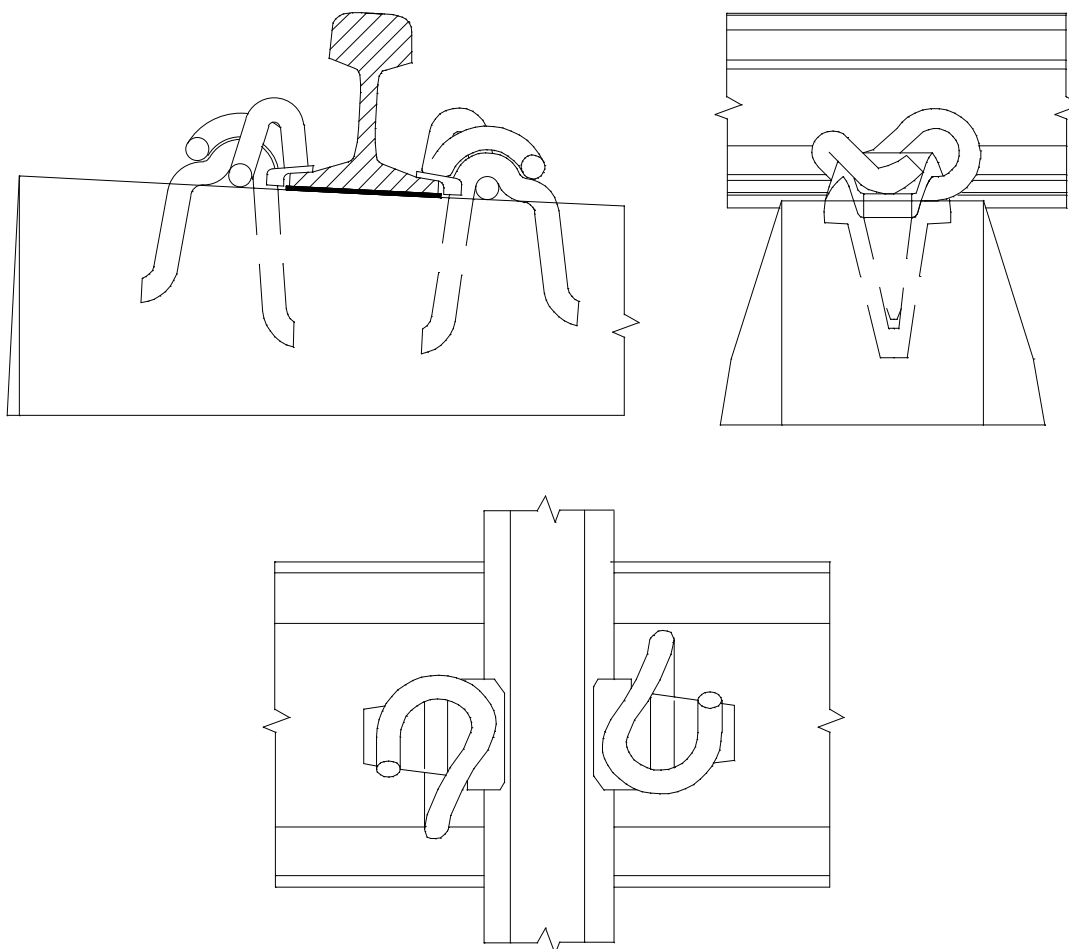

Tabell 6.a.7

Materialer til 35 kg/NSB40 / Pandrol PR / Enhetssville

Deler	Betegnelse / F.nr.		Ant. / sville
Skinner	35kg 101.035.xx	NSB40 101.140.xx	-
Fjær	PR341A (svart) 103.201.54	PR341A (svart) 103.201.54	4
Mellomlegg	Sk 1632 103.101.33	Sk 1632 103.101.33	2
Isolatorer	Sk 1587 103.101.44	Sk 1587 103.101.44	4
Sviller	NSB Enhetssville 116.003.01	NSB Enhetssville 116.003.01	-

8 NSB40/35 KG / PANDROL PR / ENHETSSVILLE SPESIAL

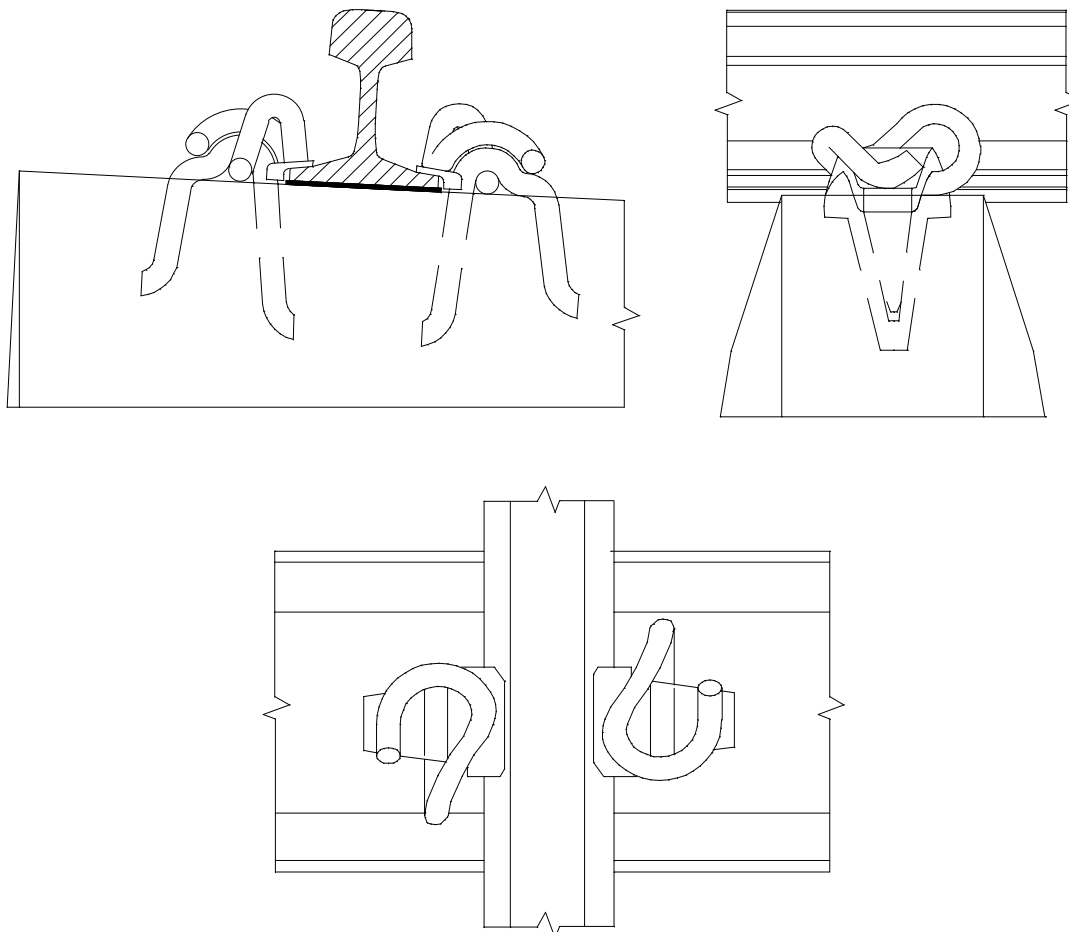

Tabell 6.a.8

Materialer til 35 kg/NSB40 / Pandrol PR / Enhetssville spesial

Deler	Betegnelse / F.nr.		Ant. / sville
Skinner	35kg 101.035.xx	NSB40 101.140.xx	-
Fjær	PR341A (svart) 103.201.54	PR341A (svart) 103.201.54	4
Mellomlegg	Sk 1629 103.101.10	Sk 1629 103.101.10	2
Isolatorer	Sk 3117 103.101.50	Sk 3117 103.101.50	4
Sviller	NSB Enhetssville spesial 116.001.01	NSB Enhetssville spesial 116.001.01	-

9 S41/S49/S54 / PANDROL PR / BETONGSVILLE 2

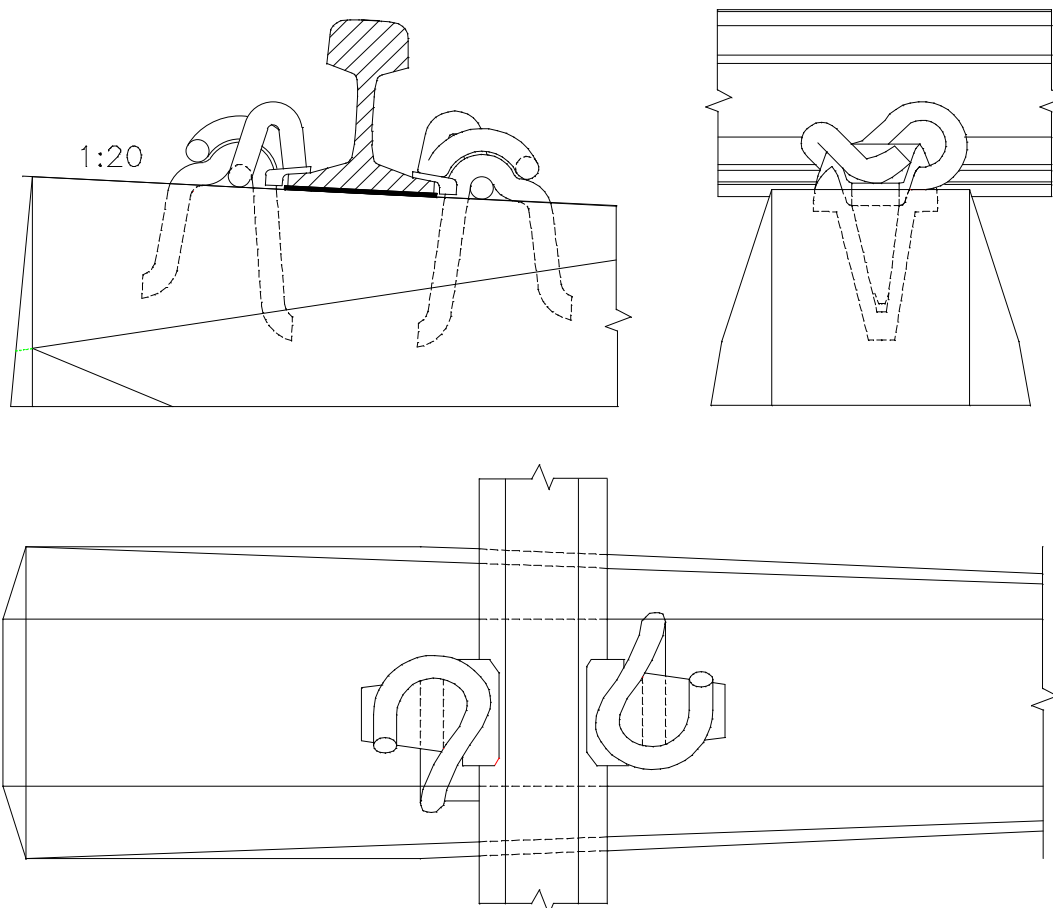

Tabell 6.a.9 Materialer til S41/S49/S54 / Pandrol PR / Betongsville type 2

Deler	Betegnelse / F.nr.			Ant. / sville
Skinner	S41 101.141.xx	S49 101.149.xx	S54 101.154.xx	-
Fjærer	PR323 (svart) 103.201.71	PR323 (svart) 103.201.71	PR323 (svart) 103.201.71	4
Mellomlegg	Sk 1632 103.101.33	Sk 1632 103.101.33	Sk 1632 103.101.33	2
Isolatorer	Sk 3117 (svart) 103.101.50	Sk 3117 (svart) 103.101.50	Sk 3117 (svart) 103.101.50	4
Sviller	Betongsville 2 116.003.02	Betongsville 2 116.003.02	Betongsville 2 116.003.02	-

10 S41/S49/S54 / PANDROL PR / BETONGSVILLE 2 MED STØPEJERNSANKER

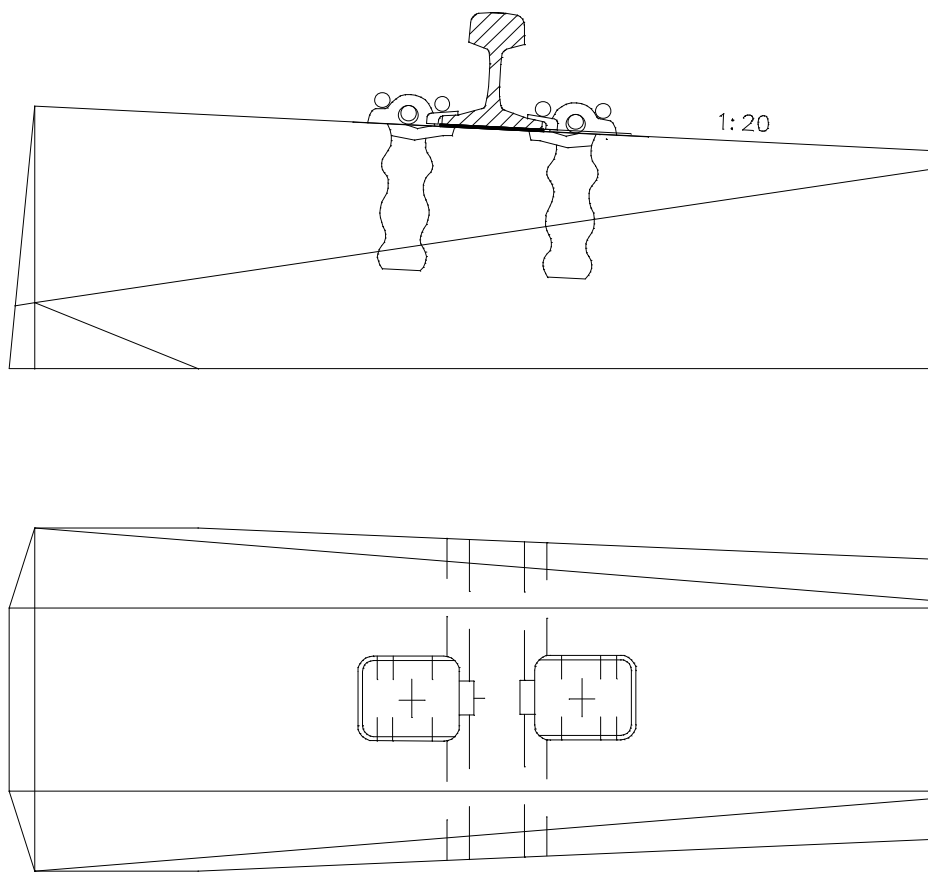

Tabell 6.a.10 Materialer til S41/S49/S54 / Pandrol PR / betongsville 2 med støpejernsanker

Deler	Betegnelse / F.nr.			Ant. / sville
Skinner	S41 101.141.xx	S49 101.149.xx	S54 101.154.xx	-
Fjærer	PR401 103.201.72	PR401 103.201.72	PR401 103.201.72	4
Mellomlegg	Sk 1632 103.101.33	Sk 1632 103.101.33	Sk 1632 103.101.33	2
Isolatorer	Sk 3117 (svart) 103.101.50	Sk 3117 (svart) 103.101.50	Sk 3117 (svart) 103.101.50	4
Sviller	Betongsville 2 m/ støpejernsanker 116.001.04	Betongsville 2 m/ støpejernsanker 116.001.04	Betongsville 2 m/ støpejernsanker 116.001.04	-

11 S41/S49 / HEY-BACK / BETONGSVILLE 2

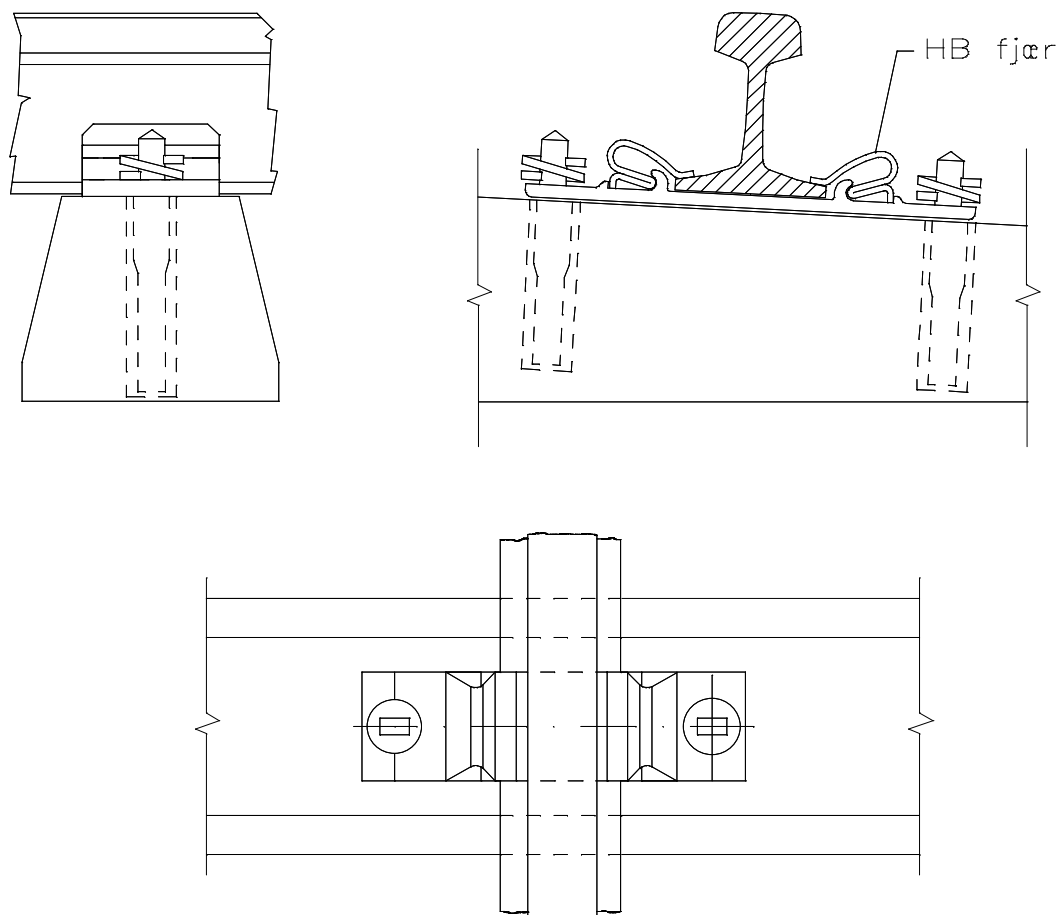

Tabell 6.a.11 Materialer til S41/S49/S54 / Hey-Back / betongsville 2

Deler	Betegnelse / F.nr.		Ant. / sville
Skinner	S41 101.141.xx	S49 101.149.xx	-
Fjærer	HBFJ49B 103.201.07	HBFJ49B 103.201.07	4
Underlagsplate	Sk 972 103.049.03	Sk 972 103.049.03	2
Mellomlegg, skinne/ plate	2,0 X 110 X 125 103.101.17	2,0 X 110 X 125 103.101.17	2
Mellomlegg, plate/sville	2,5x110x360 103.101.20	2,5x110x360 103.101.20	2
Svilleskruer	Sk 946 104.101.52	Sk 946 104.101.52	8
Sviller	Betongsville 2 116.003.03	Betongsville 2 116.003.03	-

12 S49/S54 / PANDROL E / TRESVILLER

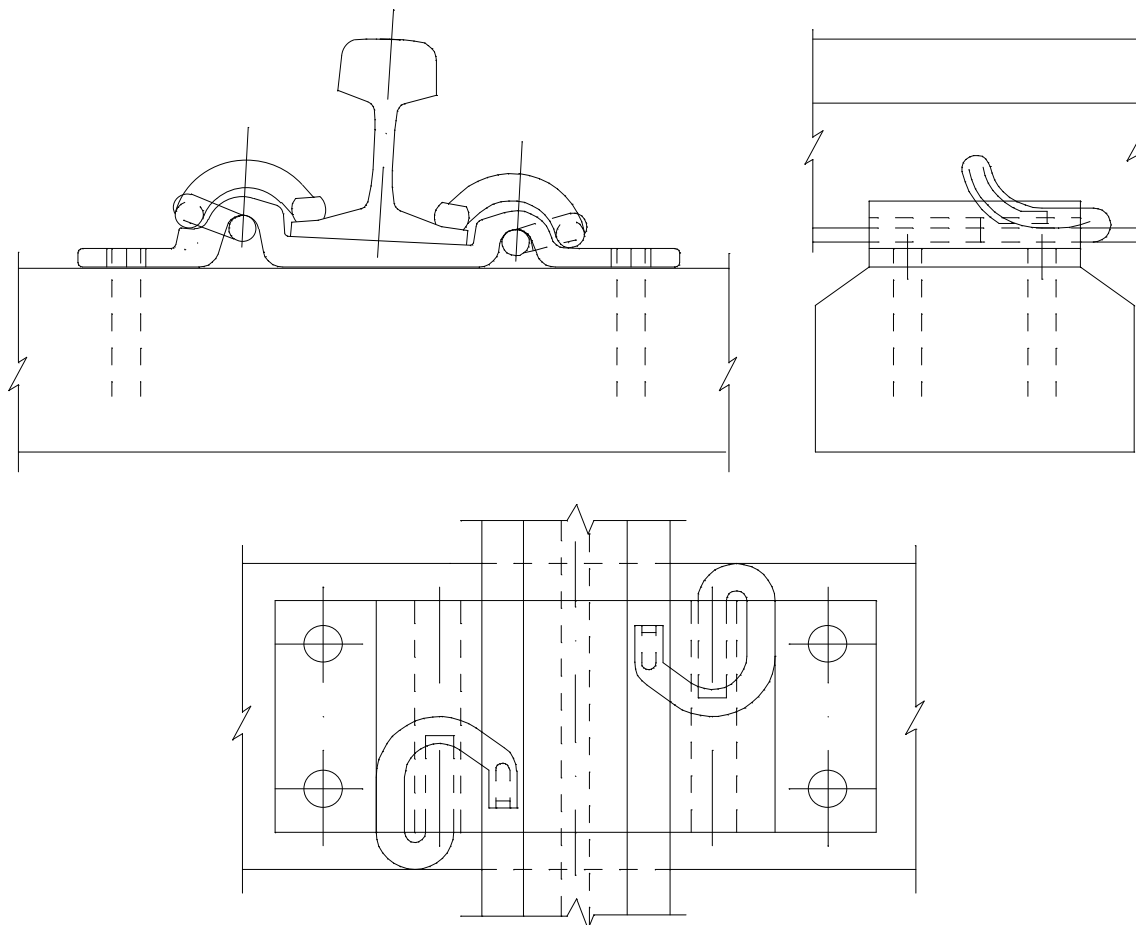

Tabell 6.a.12 Materialer til S49/S54 / Pandrol e / tresviller

Deler	Betegnelse / F.nr.		Ant. / sville
Skinner	S49 101.149.xx	S54 101.154.xx	-
Underlagsplate	Sk 3131 103.049.18	Sk 3131 103.049.18	2
Fjærer	e1877 103.201.56	e1877 103.201.56	4
Mellomlegg skinne/underlagsplate	2,0 X 170 X 125 103.101.15	ingen mellom- legg	2
Svilleskruer	Sk 1086 104.101.31	Sk 1086 104.101.31	8
Sviller	Tresville X 116.115.83	Tresville X 116.115.83	-

13 S41/S49/S54 / HEY-BACK / TRESVILLER

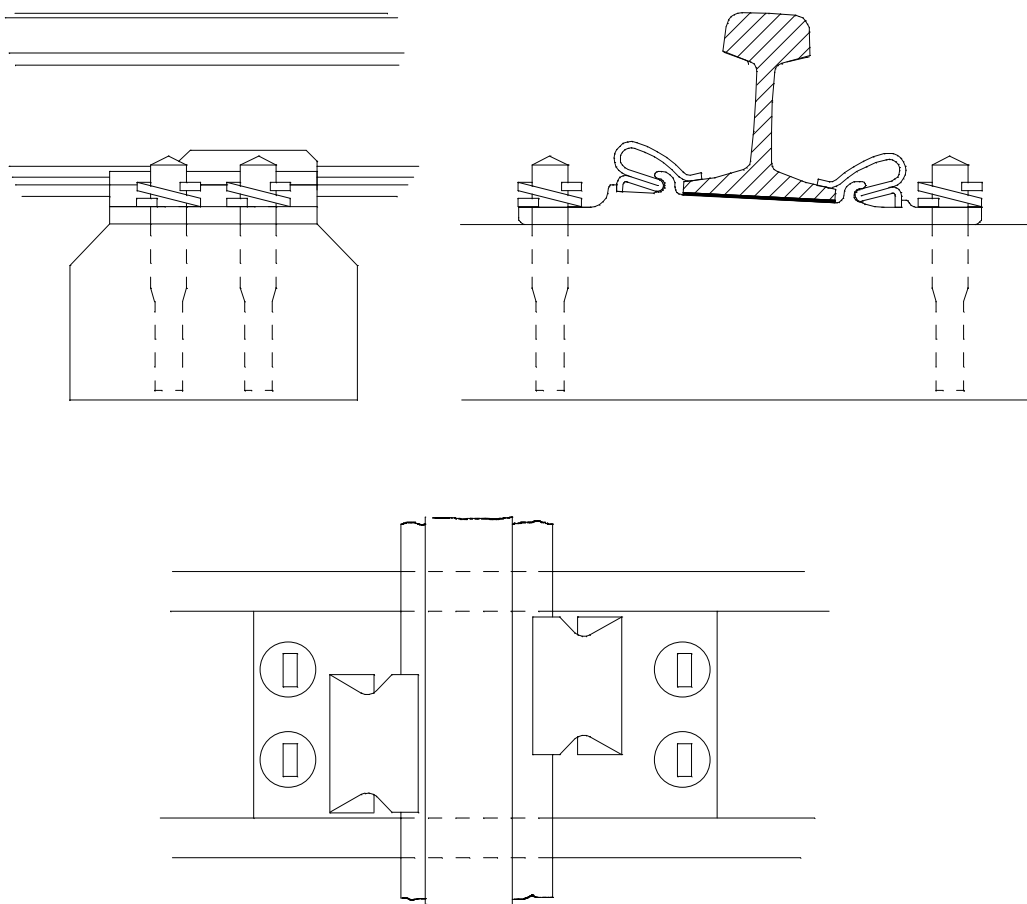

Tabell 6.a.13 Materialer til S41/S49/S54 / Hey-Back / tresviller

Deler	Betegnelse / F.nr			Ant. / sville
Skinner	S41 101.141.xx	S49 101.149.xx	S54 101.154.xx	-
Underlagsplate	Sk 691 103.049.01	Sk 691 103.049.01	Sk 691 103.049.01	2
Fjærer	HBFJ49 103.201.05	HBFJ49 103.201.05	HBFJ54 103.201.12	4
Mellomlegg	2,0 X 170 X 125 103.101.15	2,0 X 170 X 125 103.101.15	2,0 X 170 X 125 103.101.15	2
Svilleskruer	Sk 1086 104.101.31	Sk 1086 104.101.31	Sk 1086 104.101.31	8
Sviller	Tresville X 116.115.81	Tresville X 116.115.81	Tresville X 116.115.81	-

14 35KG/NSB40 / HEY-BACK / TRESVILLER

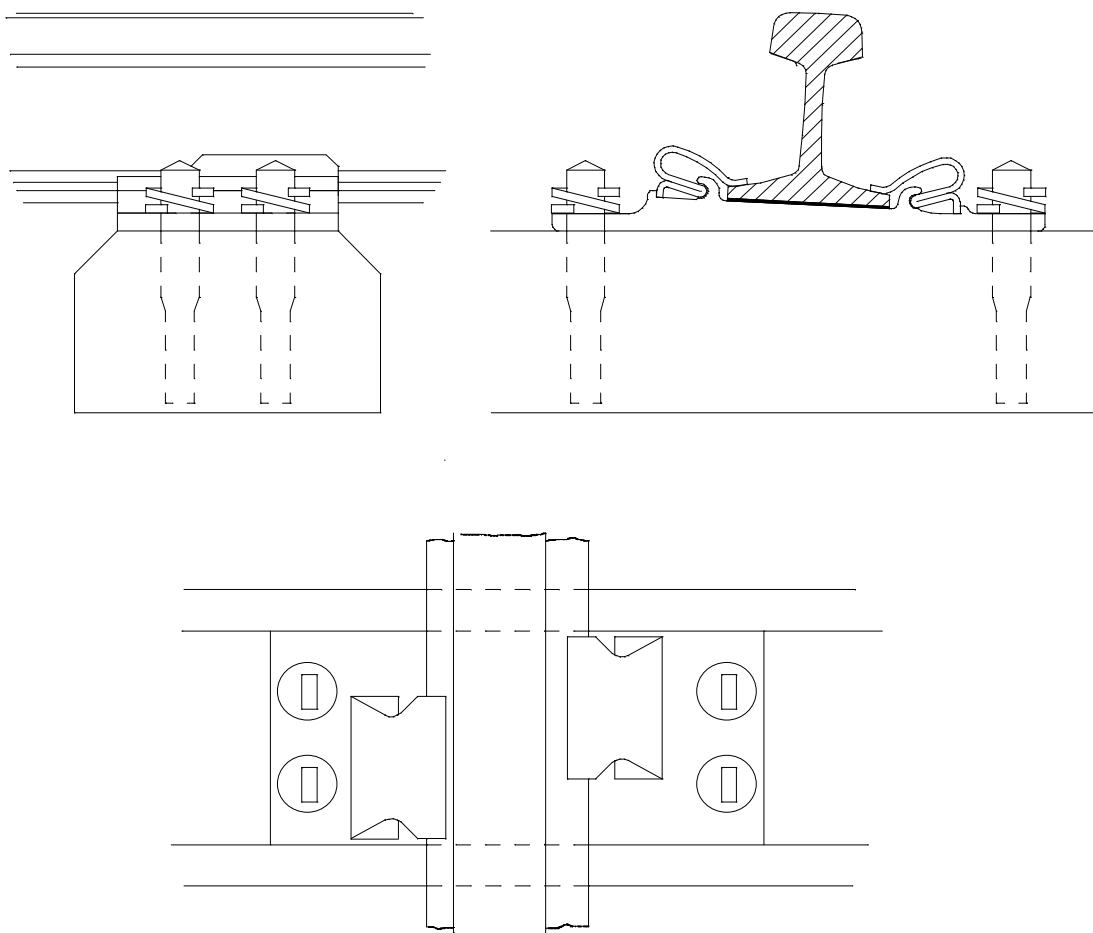

Tabell 6.a.14 Materialer til 35kg/NSB40 / Hey-Back / tresviller

Deler	Betegnelse / F.nr.		Ant. / sville
Skinner	35 kg 101.035.xx	NSB40 101.140.xx	-
Underlagsplate	Sk 695 103.035.03	Sk 695 103.035.03	2
Fjærer	HBFJ35 103.201.01	HBFJ35 103.201.01	4
Mellomlegg	2,0 X 160 X 110 103.101.16	2,0 X 160 X 110 103.101.16	2
Svilleskruer	Sk 1086 104.101.31	Sk 1086 104.101.31	8
Sviller	Tresville X 116.115.xx	Tresville X 116.115.xx	-

15 UIC54/UIC60 / NABLA / TRESVILLER

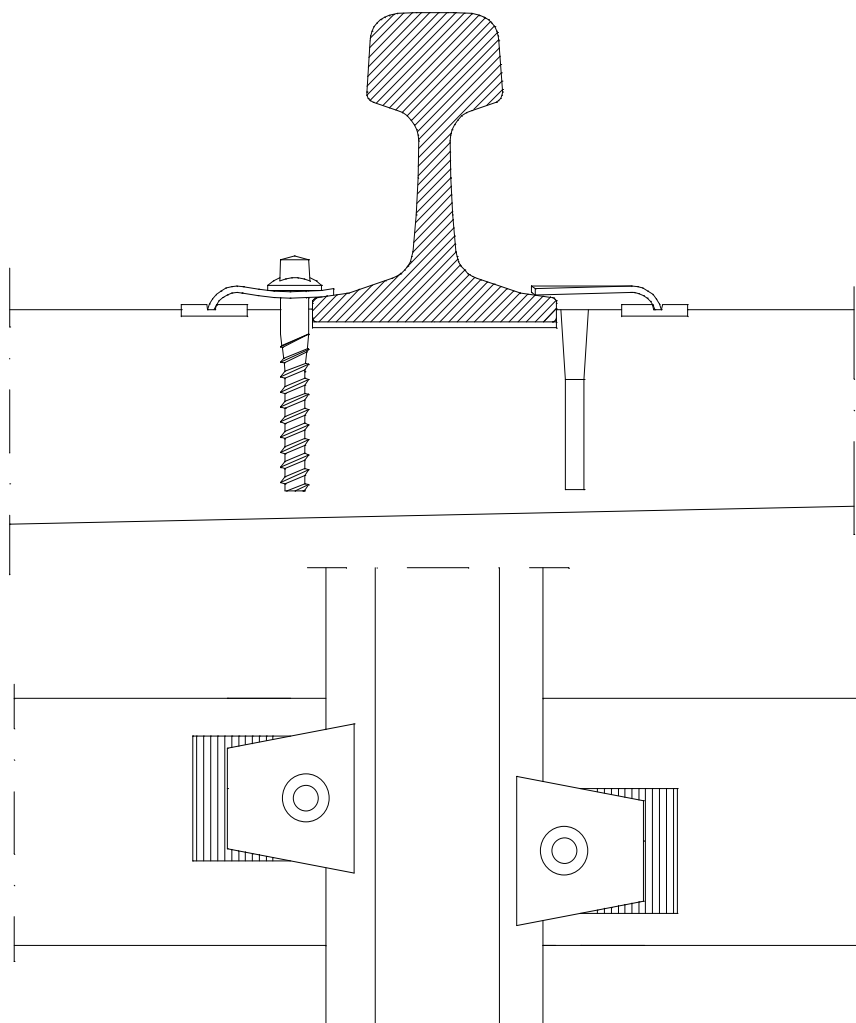

Tabell 6.a.15 Materialer til UIC54/UIC60 / Nabla / tresviller

Deler	Betegnelse / F.nr.		Ant. / sville
Skinner	UIC54	UIC60 101.160.xx	-
Mellomleggsplate	138 x 180 x 4,5 103.205.03	148 x 180 x 4,5 103.205.04	2
Fjær m/ stålplate	RNTN 1 103.205.01	RNTN 1 103.205.01	4
Svilleskruer	Sk 3141 103.205.02	Sk 3141 103.205.02	4
Sviller	Tresville X 116.115.xx	Tresville X 116.115.xx	-

16 S54/UIC54/UIC60/ DOBLE FJÆRSPIKER / TRESVILLER

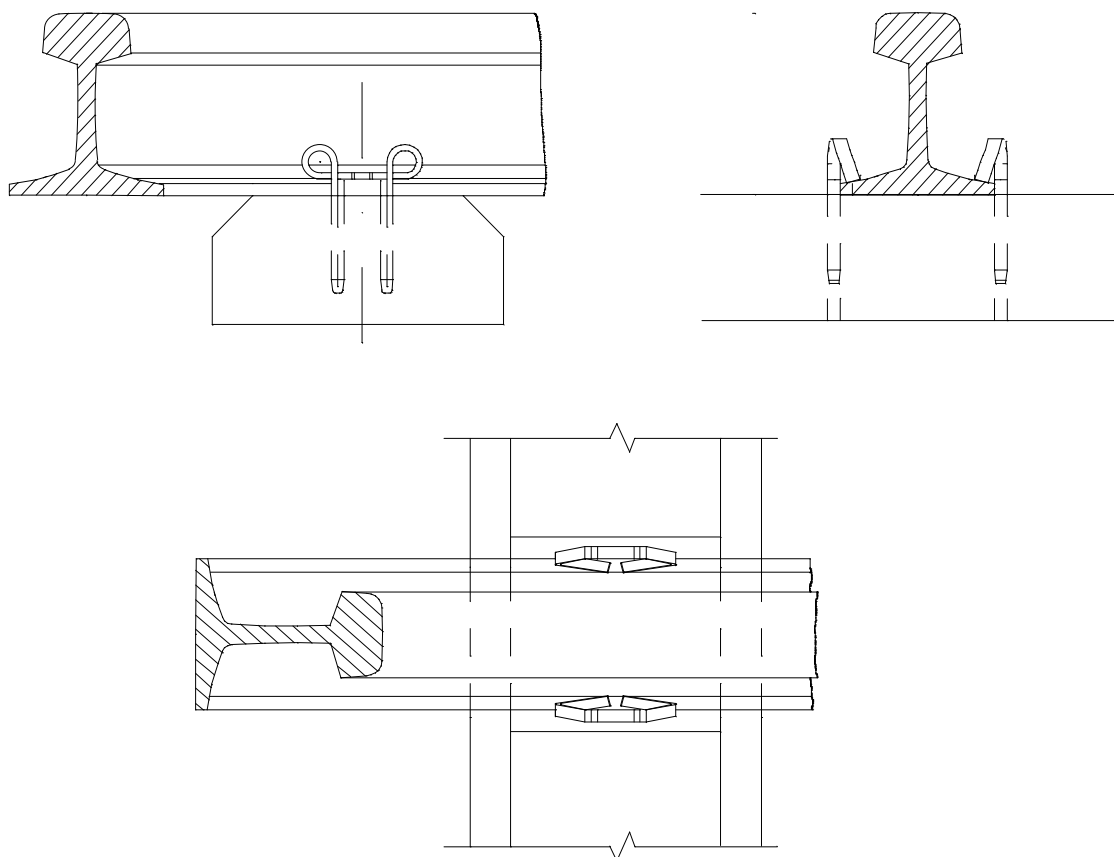

Tabell 6.a.16 Materialer til S54/UIC54/UIC60/ Doble fjærspiker / tresviller

Deler	Betegnelse / F.nr.			Ant. / sville
Skinner	UIC54	UIC60 101.160.xx	S54 101.154.xx	-
Dobble fjærspiker	Dna4 104.001.55	Dna4 104.001.55	Dna4 104.001.55	4
Sviller	Tresville X 116.115.xx	Tresville X 116.115.xx	Tresville X 116.115.xx	-

Anvendes fortrinnsvis i lange og fuktige tunneler.

17 UIC60 / PANDROL FASTCLIP/e-CLIP / BETONGSVILLE FOR SPORVEKSEL

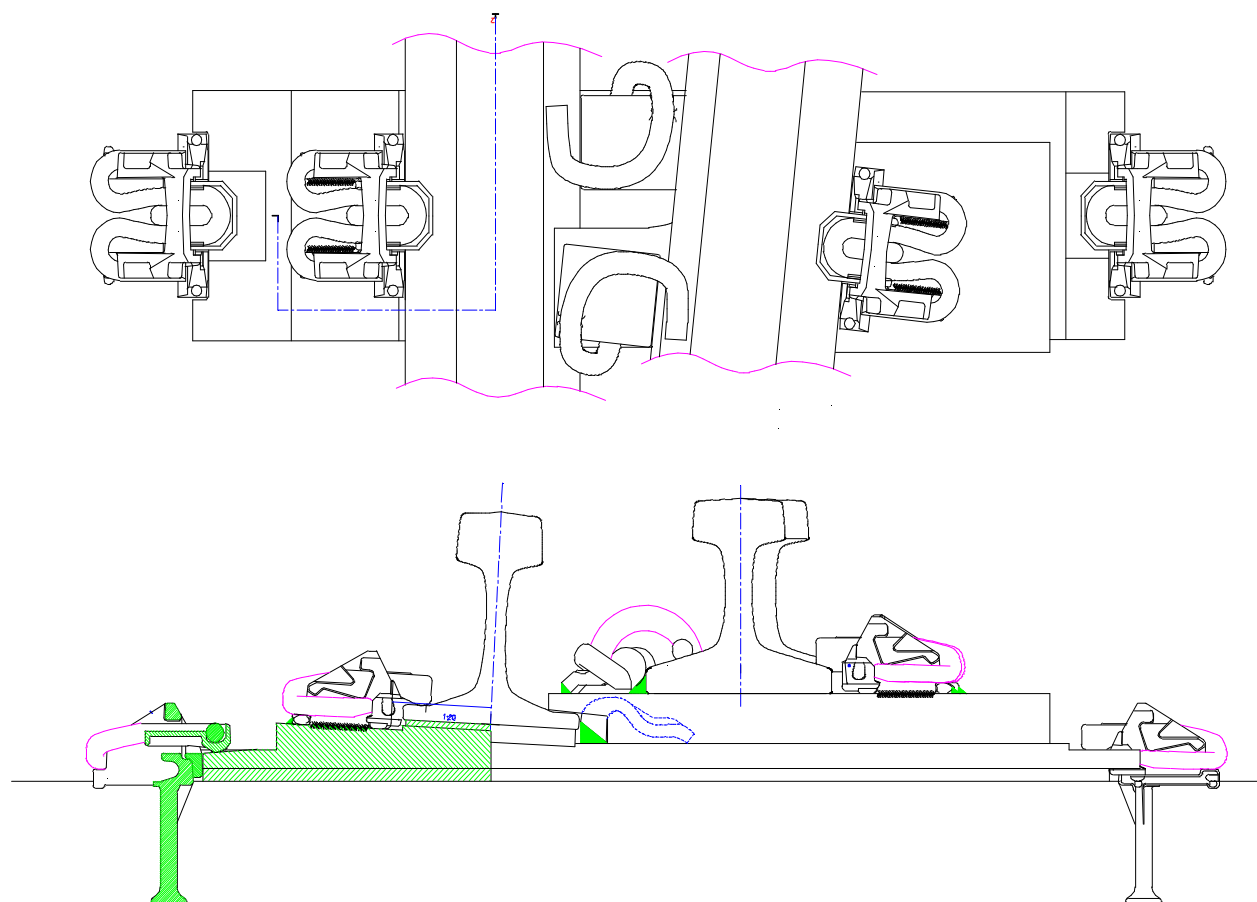

Tabell 6.a.17 Materialer til UIC60 / Pandrol Fastclip / Betongsville for sporveksel

Deler	Betegnelse	F.nr.
Skinner	UIC60	-
Fjærer	FC 1501	103.203.01
Fjærer	e 2039	103.201.58
Tåisolatorer (Fastclip)	Sk 3162	103.203.02
Sideisolatorer (Fastclip)	Sk 3163	103.203.03
Isolatorer (e-clip)	Sk 3118	103.101.58
Mellomlegg	Sk 3164	103.203.04

18 S54/UIC60 / PANDROL PR / BETONGSVILLE FOR SPORVEKSEL

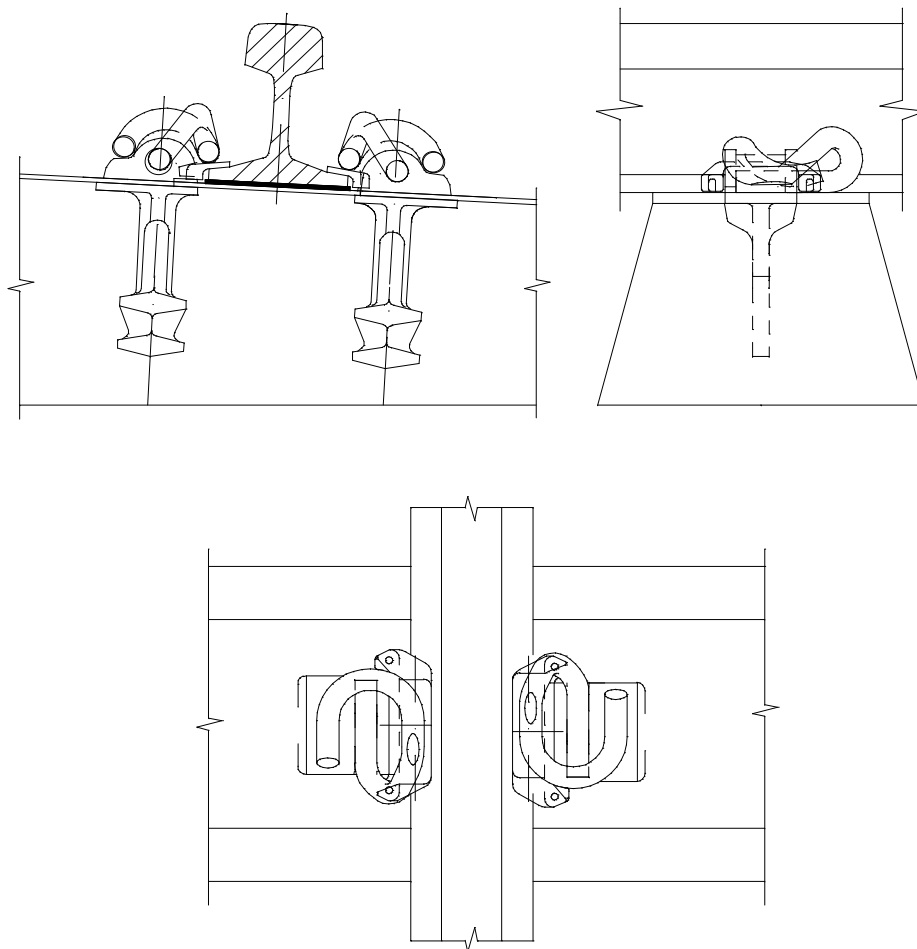

Tabell 6.a.18 Materialer til S54/UIC60 / Pandrol PR/e / Betongsville for sporveksel

Deler	Betegnelse / F.nr.	
Skinner	S54	UIC60
Fjærer	PR607A 103.201.57	PR607A 103.201.57
Isolatorer	Sk 3109 103.101.57	Sk 3118 103.101.58
Mellomleggsplate	Sk 3111 103.101.39	Sk 3125 103.101.31
Sviller	Sk 1634	Sk 1634

19 S49 / PANDROL PR / BETONGSVILLE FOR SPORVEKSEL

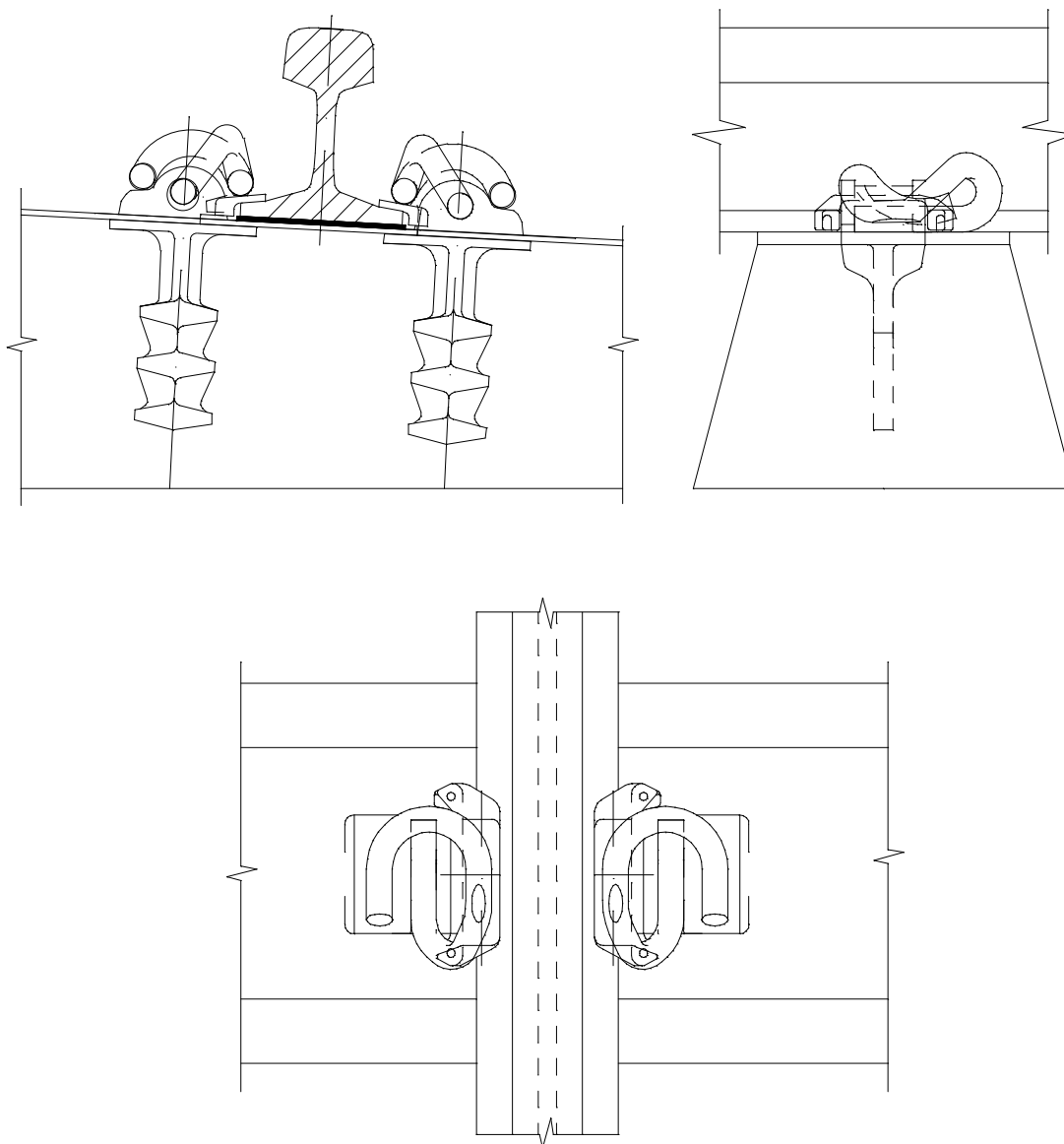

Tabell 6.a.19 Materialer til S49 / Pandrol PR / Betongsville for sporveksel

Deler	Betegnelse	F.nr.
Skinner	S49	-
Fjærer	PR341A	103.201.54
Isolatorer	Sk 1581	103.101.49
Mellomlegg	Sk 1571	103.101.35
Sviller	Sk 1634	-