



<input type="checkbox"/>	Godkjent
<input type="checkbox"/>	Godkjent m/kommentarer
<input type="checkbox"/>	Ikke godkjent Revider og send inn på nytt
<input type="checkbox"/>	Kun for informasjon
Dato:                      Sign:	

## Network Design Grounding principles

04D	Fullstendig referanse til CW-jordingsdokumenter. Andre endringer iht. kommentarer på forrige revisjon	19.12.06	GBH	VS	BE
03D	As Built	04.05.06	GBH	VS	BE
02C	Justering av løsninger for el.baner (etter avklaringsmøte med JBV 8/3-2003).	10.03.04	GBH	VS	BE
01D	As Built	09.03.04	BE	GBH	VS
00C		26.11.03	SvS/ GBH	BE	LB
Revisjon		Dato:	Utarb. av	Kontr. av	Godkj. av
Tittel <b>Network Design – Grounding Principles</b>		Målestokk: Utarbeidet av: <b>SIEMENS AS</b>			
Prosjekt: <b>GSM-R</b> SoL ID: <b>00 Generelt GSM-R prosjektet</b> Site ID: <b>NA</b> Delsys.: <b>High Level</b>		Erstatning for:		Antall sider 22 + 0 vedl.	
		FDV nummer: TE.800114-000			
 <b>Jernbaneverket</b>		Dokumentnummer: <b>GSM-00-A-20059</b>		Revisjon <b>04D</b>	

<b>GSM-R Project</b>	<b>Network Design Grounding Principles</b>	Doc.no: GSM-00-A-20059 Date: 19.12.06 Rev.: 04D Page 2 of 22
----------------------	--	---

<b>1</b>	<b>GENERAL.....</b>	<b>3</b>
<b>2</b>	<b>GROUNDING PRINCIPLES CENTRAL ROOMS.....</b>	<b>4</b>
2.1	GROUNDING OF RACK BASED SYSTEMS TO THE ROOM GROUND.....	4
2.2	GROUNDING OF FREE STANDING EQUIPMENT E.G. TERMINALS AND PC'S .....	4
<b>3</b>	<b>GROUNDING PRINCIPLES BTS AND MW SITES.....</b>	<b>5</b>
3.1	NON-ELECTRICAL LINES.....	5
3.2	ELECTRICAL LINES.....	5
<b>4</b>	<b>GROUNDING PRINCIPLES TUNNEL SYSTEM.....</b>	<b>6</b>
4.1	DRAWING SYMBOLS.....	7
4.2	GENERAL GROUNDING AND SHIELDING PRINCIPLES.....	8
4.2.1	<i>General for all lines (electrical and non-electrical)</i> .....	8
4.2.2	<i>Non-electrical lines</i> .....	8
4.2.3	<i>Electrical lines</i> .....	9
4.3	GROUNDING AND PROTECTION OF RF-REPEATERS INCLUDING PICK-UP PATH (DONOR PATH).....	10
4.4	GROUNDING AND PROTECTION OF REMOTE UNIT (OPTICAL REPEATER).....	11
4.5	GROUNDING AND PROTECTION OF TUNNEL FEEDERS, ANTENNAS AND RADIATING CABLE FOR NON-ELECTRIC LINES.....	12
4.5.1	<i>1 x RF-Repeater and tunnel antenna</i> .....	12
4.5.2	<i>1 x RF-Repeater and radiating cable with 50 ohm termination</i> .....	12
4.5.3	<i>1 x RF-Repeater and radiating cable with antenna inside the tunnel</i> .....	13
4.5.4	<i>1 x RF-Repeater and radiating cable with antenna outside the tunnel</i> .....	13
4.5.5	<i>2 x RF-Repeater and radiating cable</i> .....	14
4.5.6	<i>Overlap/HO-antenna on the repeater side</i> .....	14
4.5.7	<i>1 x Remote Unit and antennas</i> .....	15
4.5.8	<i>1 x Remote Unit and radiating cable</i> .....	15
4.5.9	<i>Combinations of Remote Unit and RF-Repeater with radiating cable or 2 x Remote Unit with radiating cable</i> .....	16
4.6	GROUNDING AND PROTECTION OF TUNNEL FEEDERS, ANTENNAS AND RADIATING CABLE FOR ELECTRIC LINES.....	17
4.6.1	<i>1 x RF-Repeater and tunnel antenna</i> .....	17
4.6.2	<i>1 x RF-Repeater and radiating cable with 50 ohm termination</i> .....	17
4.6.3	<i>1 x RF-Repeater and radiating cable with antenna inside the tunnel</i> .....	18
4.6.4	<i>1 x RF-Repeater and radiating cable with antenna outside the tunnel</i> .....	18
4.6.5	<i>2 x RF-Repeater and radiating cable</i> .....	19
4.6.6	<i>Overlap/HO-antenna on the repeater side</i> .....	19
4.6.7	<i>1 x Remote Unit and antennas</i> .....	20
4.6.8	<i>1 x Remote Unit and radiating cable</i> .....	20
4.6.9	<i>Combinations of Remote Unit and RF-Repeater with radiating cable or 2 x Remote Unit with radiating cable</i> .....	21
<b>5</b>	<b>GROUNDING REQUIREMENTS FOR DIFFERENT ROLL-OUT SITE TYPES.....</b>	<b>21</b>

<b>GSM-R Project</b>	<b>Network Design Grounding Principles</b>	Doc.no: GSM-00-A-20059 Date: 19.12.06 Rev.: 04D Page 3 of 22
----------------------	--	---

## 1 General

This document describes the general grounding principles for the Jernbaneverket GSM-R project for the systems delivery. The document is a subset of the High level network Description.

The following types of installation scenarios are covered:

- Central rooms
  - Marienborg Trondheim
  - BSC locations
  - Dispatcher TCC locations
- BTS and MW sites
- Tunnel systems

This document gives only the principal solution of the grounding system. There are grounding solutions that differ from this principal solution depending on local conditions and requirements. Please refer to the relevant Site Design Report for Civil Work and System for details on each site.

<b>GSM-R Project</b>	<b>Network Design Grounding Principles</b>	Doc.no: GSM-00-A-20059 Date: 19.12.06 Rev.: 04D Page 4 of 22
----------------------	--	---

## **2 Grounding principles central rooms**

This part describes the following :

- Grounding of rack based systems to the room ground
- Grounding of free standing equipment like terminals and PC's

### **2.1 Grounding of rack based systems to the room ground**

All rack based systems follow this scheme:

- All sub rack within a rack are connected to rack grounding bar within rack with cable of min 16 mm<sup>2</sup> dimension .
- Rack grounding shall be made on site by using a 5AWG( 16mm<sup>2</sup>) or 3 AWG(25 mm<sup>2</sup>) copper cable or copper band dependent on length. The resistance of the ground cable must not exceed 0,1 ohm.
- The grounding principle are following the tree structure.
- Connection point to room ground must be provided by CW contractor.

Further details required for engineering are found in each systems installation manual

### **2.2 Grounding of free standing equipment e.g. terminals and PC's**

Grounding of free standing equipment is dependent on the equipment type (e.g. Shielded system, double insulated system). The installation manual per equipment type must be used as a reference, and the engineering be done on a per installation basis.

### 3 Grounding principles BTS and MW sites

#### 3.1 Non-electrical lines

This part describes the following :

- Grounding of antenna and cable for the MW equipment
- Grounding of the systems and rack within the equipment hut.
- Termination of ground from the feeder cable on the BTS side.

The figure below describes the grounding principles for equipment on BTS and/or MW sites. The grounding scheme for the Grounding Plate at the hut are dependent on site location, please see chapter 5 “Grounding requirements for different roll-out site types” for requirements for the different sites type. The grounding planning for the hut are done on a per site basis, so see site documentation for such info.

The grounding shall be made on site by using a 5AWG( 16mm<sup>2</sup>) or 3 AWG(25 mm<sup>2</sup>) copper cable or copper band dependent on length. The resistance of the ground cable must not exceed 0,1 ohm. The connection with the cable duct or grounding plate are done with a C-press Rk35mm<sup>2</sup> Yellow/Green.

Further details required for engineering are found in each systems installation manual

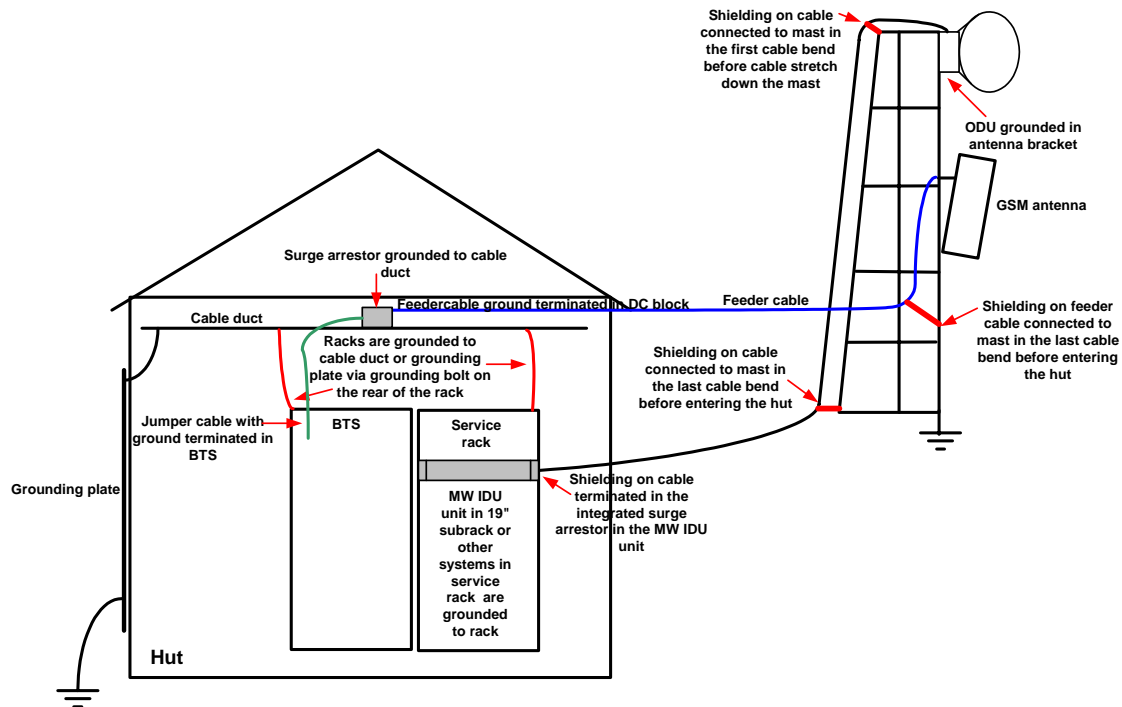

Figure 1 Grounding principles MW and BTS sites

#### 3.2 Electrical lines

There are no BTS/MW sites planned within the “slyngfelt” of electrical lines. However, this document will be revised and altered accordingly if this should occur in the future.

<b>GSM-R Project</b>	<b>Network Design Grounding Principles</b>	Doc.no: GSM-00-A-20059 Date: 19.12.06 Rev.: 04D Page 6 of 22
----------------------	--	---

## 4 Grounding principles tunnel system











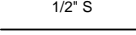
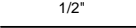
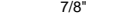
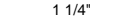
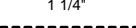









This chapter includes description of the different grounding and protection concepts for repeater systems in tunnel. The concepts are divided into two main categories:

- Non-electric lines (tunnels in areas with diesel locomotives)
- Electric lines (tunnels in areas with electric locomotives)

Any description of the connection from the ground plate to the main ground are covered in chapter 5 in this document. That includes any "impedans trafo" etc. potentially needed to separate local ground from rail ground.

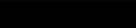
**The description shows the concepts, and is not a building document!**

## 4.1 Drawing symbols

	Optical Fiber
	Jumper: 1/2" Superflex
	1/2" Coax
	7/8" Coax
	1 1/4" Coax
	1 1/4" Radiating Coax
	Grounding Cable
	Grounding Kit
	50 Ohm End Resistor
	Surge Arrestor
	DC-Block
	Directional Coupler
	Splitter
	Hybrid Coupler
	3 way splitter
	7/16 Female connector
	7/16 Male connector
	N Female connector
	N Male connector
	SMA Female connector
	SMA Male connector
	Ground plate
	Skinne jord , Utjevningforbindelse til banestrømmens returrets (ref. JBV Regelverk JD 510). The symbol includes filters/impedance trafos etc.
	Earthing point
	Shelter wall

<b>GSM-R Project</b>	<b>Network Design Grounding Principles</b>	Doc.no: GSM-00-A-20059 Date: 19.12.06 Rev.: 04D Page 8 of 22
----------------------	--	---

## 4.2 General Grounding and Shielding Principles

### 4.2.1 General for all lines (electrical and non-electrical)

1. Antennas
  - a. Antennas are grounded by installing a ground cable to one of the brackets. The antenna pole (if made of metal) will also be grounded through the ground cable on the brackets.
  - b. Antennas located outside the tunnel must always be grounded for lightning protection.
  - c. If the antenna is grounded (local ground/rail ground), a DC block will be introduced to separate the ground potentials.
2. Repeaters
  - a. The RF-Repeater, Master Unit and Remote Unit are grounded on the ground connector on the cabinet. The ground cable is connected to the ground bar in the shelter or installation frame (in tunnel)
3. Feeder cables
  - a. All main feeder cables will be grounded close to the repeater equipment.
4. DC blocks
  - a. The introduction of DC-blocks is done to protect equipment against harmful currents, and most important to protect personnel from possible contact with current carrying devices.
  - b. DC-blocks separate different ground potentials to avoid undesired currents through the equipment.
  - c. DC-blocks are also used to avoid health risk to personnel in case of current leakage, lightning etc.
  - d. A possible hazard is when the electrical lines get in contact with the equipment (e.g. cable connectors) which might have fatal consequences. The DC-block will in this case prevent the flow of current!
5. Surge arrestors
  - a. A surge arrestor will be introduced where there is a risk of lightning. That is in relation to antennas in the open. The surge arrestor also covers the grounding kit function.
6. Separate groundings
  - a. If the distance between an antenna pole/mast and the equipment shelter is more than 20m, separate groundings shall be established. [1] (JD 560 chapter 9, section)
7. Risk of lightning
  - a. When there is a risk for lightning a local ground must be established. In this case the antenna must be connected both to local ground and the rail ground. Then it is not necessary to isolate the antenna from the rock.

### 4.2.2 Non-electrical lines

1. General
  - a. Antennas and radiating cables in tunnels will not be grounded.
2. Antennas
  - a. The antenna must be isolated from the rock to avoid different ground potential between the antenna and the repeater equipment if the antenna doesn't have local ground.
3. DC-block
  - a. The DC-block will be of type 3kV.



<b>GSM-R Project</b>	<b>Network Design Grounding Principles</b>	Doc.no: GSM-00-A-20059 Date: 19.12.06 Rev.: 04D Page 9 of 22
----------------------	--	---

### 4.2.3 Electrical lines

1. General
  - a. The fundamental difference between electrical and non-electrical lines is the aerial contact wire and the return current in the rails.
  - b. According to JBV regulations [2] (JD510, chapter 6, section 2.1) all conductive elements within 5m from the centre of the track ("slyngfelt") shall be grounded to the rails or longitudinal earth wire if present. See JD510 for further clarifications.
  - c. Every antenna and radiating cable in the tunnel (in the "slyngfelt") shall be grounded.
2. Antennas
  - a. The antennas should always be isolated from the tunnel rock to avoid return current from the train to flow trough the antenna.
3. Repeaters
  - a. It is important to isolate the repeater equipment grounding (shelter or installation frame) from other ground potentials, in order protect the repeater equipment from undesired current flow.
  - b. The installation frame for the repeater inside the tunnel has to be isolated from the rock to avoid current running trough the repeater into the rock (ground). The frame will be grounded to the rail grounding.
4. DC-Block
  - a. The DC-block will be of type 15kV.
5. Rail ground (Skinnejord)
  - a. The "skinnejord" symbol ("rail ground") in the drawings indicates that the earthing must be connected to the rail ground system. It does not consider potentially needed filters like "impedans trafo" etc. This will be included in the civil work documentation. See chapter 5.

<b>GSM-R Project</b>	<b>Network Design Grounding Principles</b>	Doc.no: GSM-00-A-20059 Date: 19.12.06 Rev.: 04D Page 10 of 22
----------------------	--	--

### 4.3 Grounding and Protection of RF-Repeaters including pick-up path (donor path)

In this chapter the following principles are described:

- grounding of RF-Repeater cabinet
- grounding and protection of pick-up path (donor path) of the RF-Repeater. The same principle applies to overlap/HO-antennas mounted on the wall

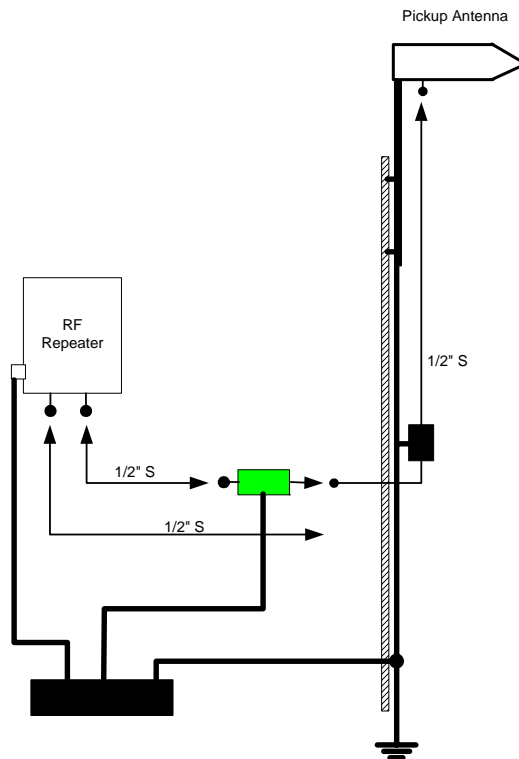

**Figure 1** RF-Repeater and Pickup Antenna. The same principles applies to other overlap/HO-antennas mounted on the wall.

- When the pickup antenna is mounted on the repeater shelter, the strong bending on the feeder cable just before it enters the shelter, can possibly be an exit point for lightning. Due to this the grounding kit is situated before the bend.
- If the antenna is more than 20m from the shelter, a local ground should be established. In that case, the two grounds should be connected to offset the difference in ground potential. In this way a DC-block will be avoided.

#### 4.4 Grounding and Protection of Remote Unit (optical repeater)

In this chapter the following principles are described:

- grounding of Remote Unit cabinet

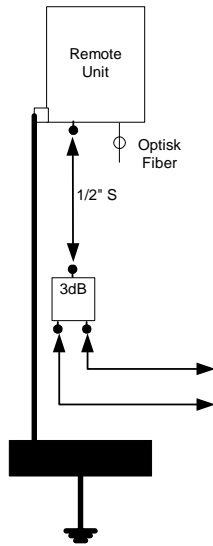

**Figure 2** Grounding of Remote Unit.

## 4.5 Grounding and Protection of tunnel feeders, antennas and radiating cable for non-electric lines

### 4.5.1 1 x RF-Repeater and tunnel antenna

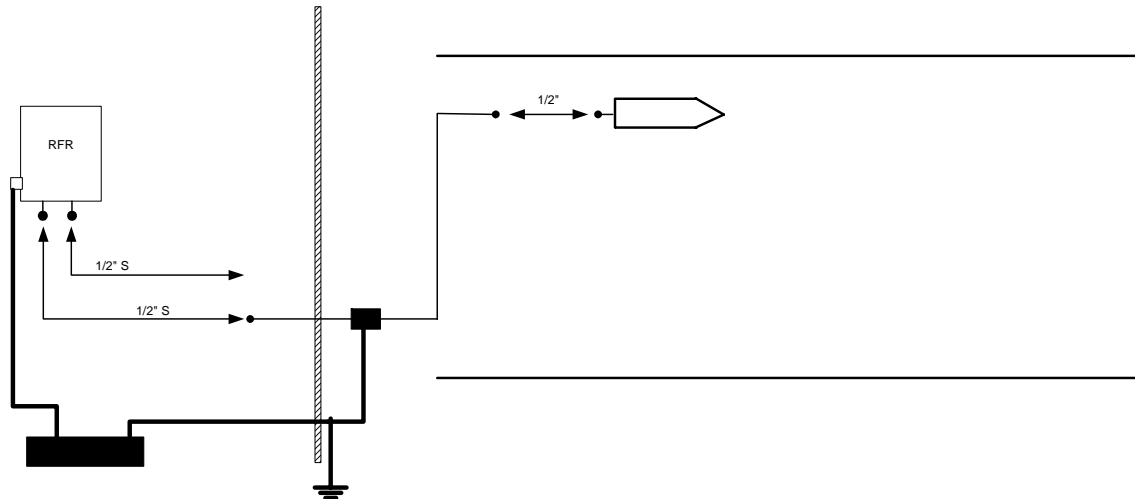

**Figure 3** RF-Repeater and Tunnel Antenne

- The coverage antenna is isolated from the tunnel rock to avoid a different ground potential between the antenna and the equipment.

### 4.5.2 1 x RF-Repeater and radiating cable with 50 ohm termination

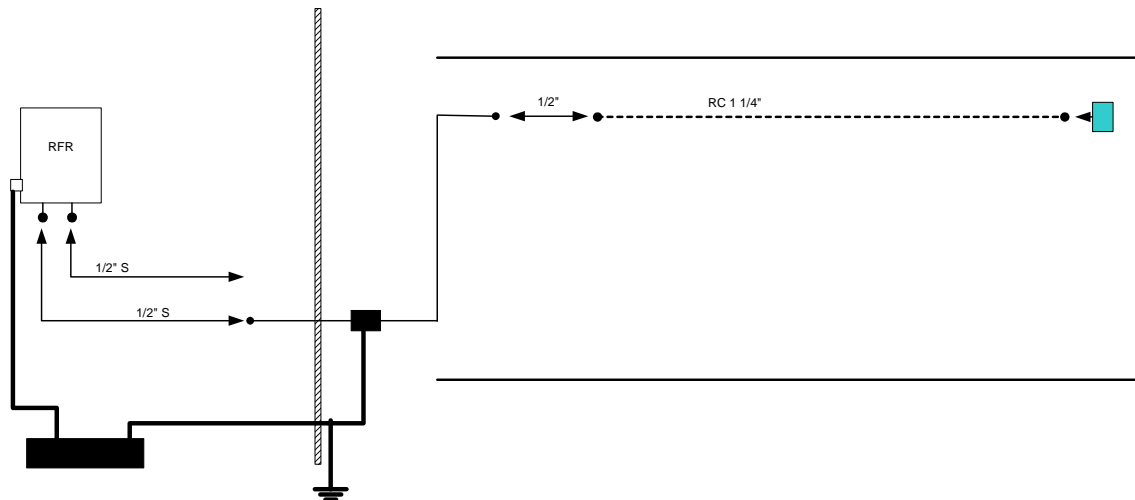

**Figure 4** RF-Repeater and RC with 50 Ohm termination.

### 4.5.3 1 x RF-Repeater and radiating cable with antenna inside the tunnel

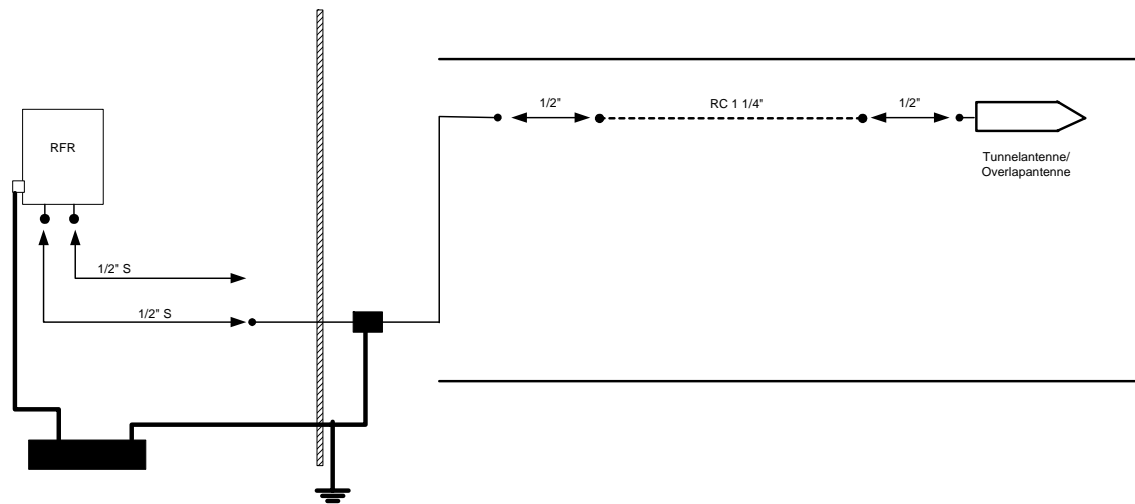

**Figure 5** RF-Repeater, RC and Overlap Antenna inside the tunnel.

- The antenna is isolated from the tunnel rock to avoid a different ground potential between the antenna and the equipment.

### 4.5.4 1 x RF-Repeater and radiating cable with antenna outside the tunnel

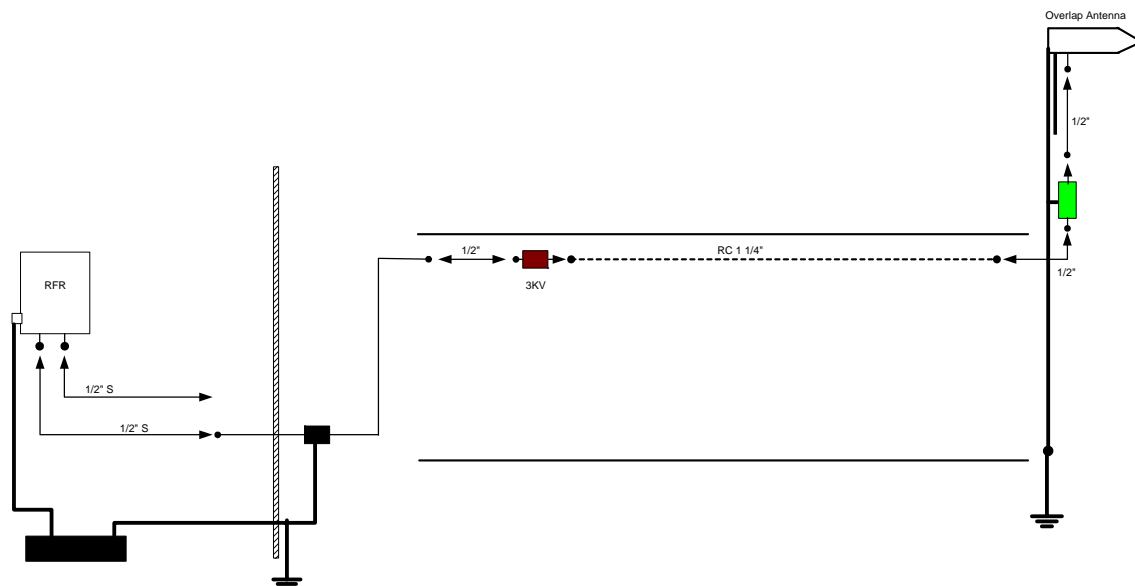

**Figure 6** RF-Repeater, RC and Overlap Antenna outside the tunnel.

- A surge arrester is connected close to the antenna to protect the radiating cable and the repeater equipment against lightning. The surge arrester is connected to the ground cable coming from the antenna. Local ground is established.
- The DC-block separates the two local grounds, and it is not necessary to isolate the antenna from the rock.

#### 4.5.5 2 x RF-Repeater and radiating cable

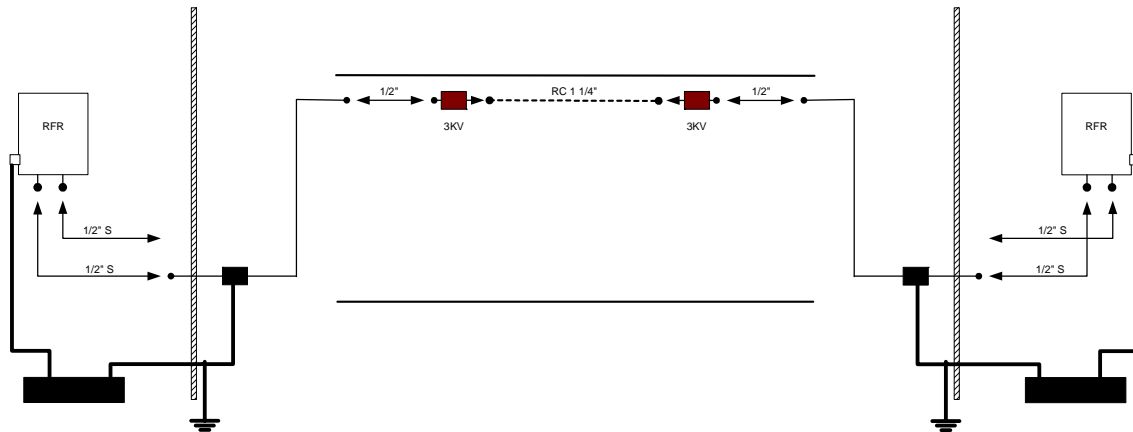

Figure 7 2 RF-repeaters and RC.

- The DC -blocks separates the two local grounds.
- There is one DC-block on each side of the radiating cable for safety reasons. That is to avoid a possible current flow during the installation. It is also convenient for standardisation of the installation.

#### 4.5.6 Overlap/HO-antenna on the repeater side

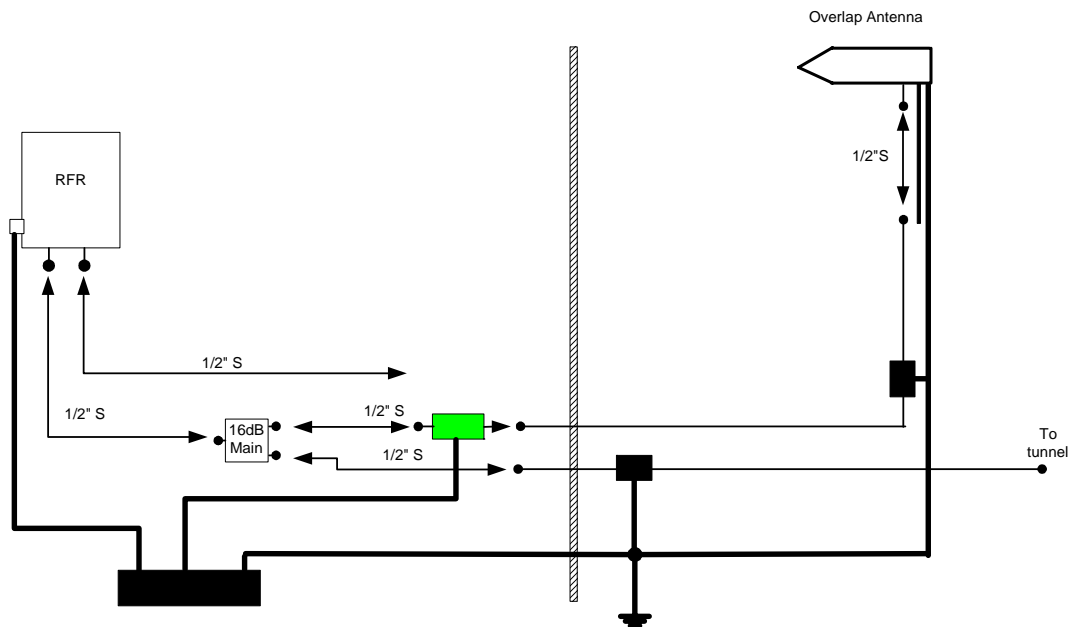
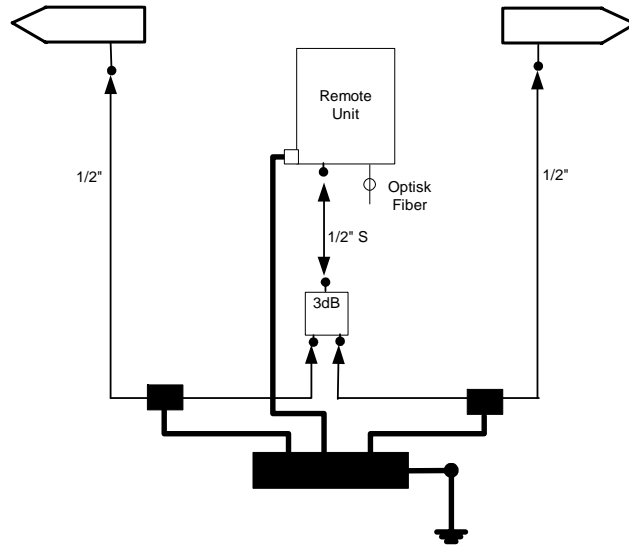

Figure 8 RF-Repeater and Overlap Antenna on the repeater side.

- The antenna is isolated from the tunnel rock to avoid a different ground potential between the antenna and the equipment.
- If the antenna is more than 20m from the shelter, a local ground should be established. If the distance is considerable (>~100m) a DC-block should be introduced like in chapter 4.6.6.

#### 4.5.7 1 x Remote Unit and antennas



**Figure 9** Remote Unit and Antennas.

- In this case it is not necessary to isolate the antenna from the rock since the equipment is close to the antennas.

#### 4.5.8 1 x Remote Unit and radiating cable

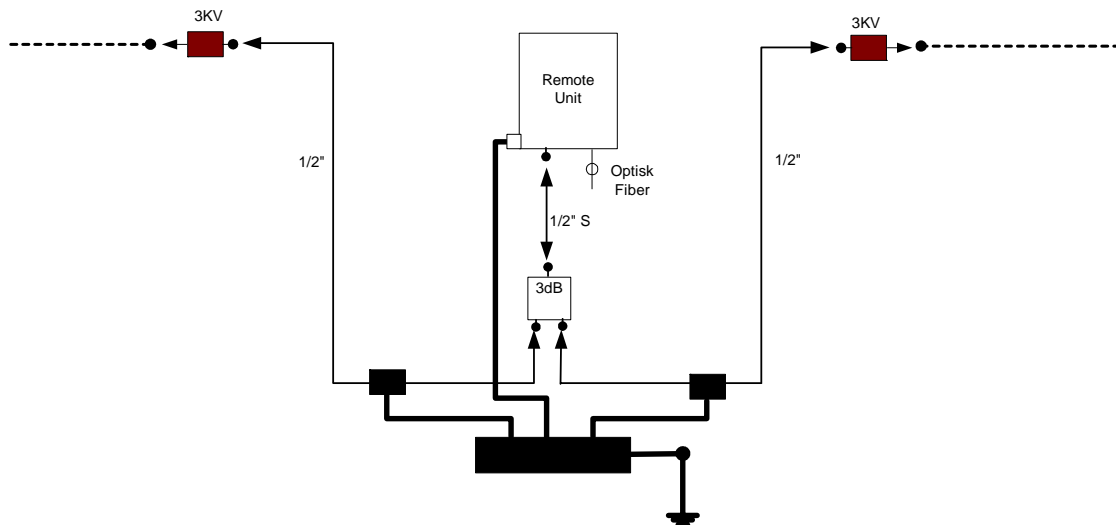

**Figure 10** Remote Unit and RC

- The DC -blocks separates the local ground for the Remote Unit from the two different equipment grounds (one on each side).

<b>GSM-R Project</b>	<b>Network Design Grounding Principles</b>	Doc.no: GSM-00-A-20059 Date: 19.12.06 Rev.: 04D Page 16 of 22
----------------------	--	--

#### **4.5.9 Combinations of Remote Unit and RF-Repeater with radiating cable or 2 x Remote Unit with radiating cable**

##### **4.5.9.1 RF-Repeater and Remote Unit with radiating cable**

For the RF-Repeater use the same principle as for

##### **2 x RF repeater and radiating cable**

For the Remote Unit use the same principle as described for

##### **1 x Remote Unit and radiating cable.**

##### **4.5.9.2 2 x Remote Unit with radiating cable**

For each Remote Unit use the same principle as described for

##### **1 x Remote Unit and radiating cable.**



## 4.6 Grounding and Protection of tunnel feeders, antennas and radiating cable for electric lines

### 4.6.1 1 x RF-Repeater and tunnel antenna

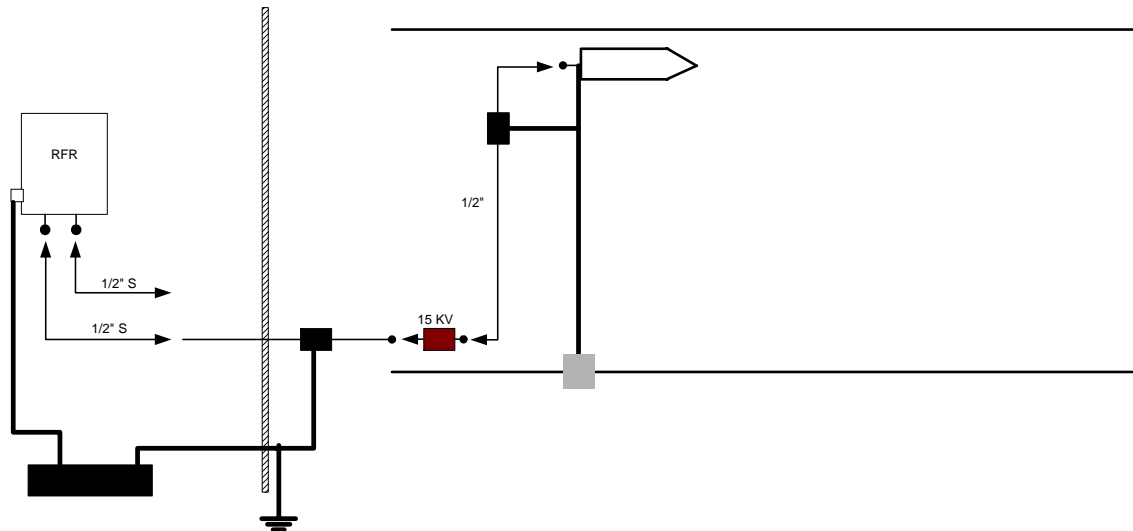

**Figure 11** RF-Repeater and Tunnel Antenna.

- The antenna is isolated from the tunnel rock to avoid return current from the train to flow trough the antenna.
- The DC-block (inside the tube or cable trace) isolates the rail ground from the ground in the equipment shelter, and prevent all DC currents from flowing through the cables.

### 4.6.2 1 x RF-Repeater and radiating cable with 50 ohm termination

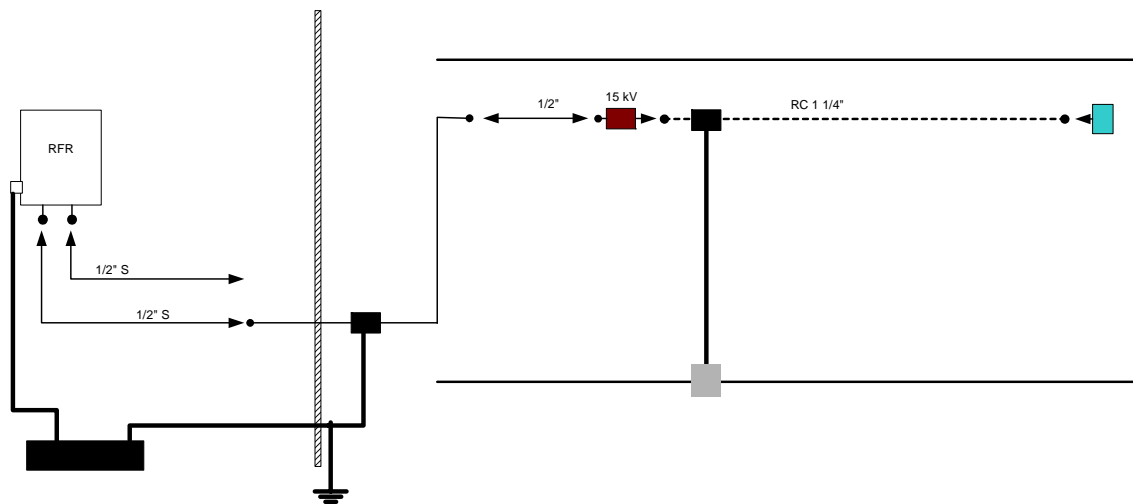

**Figure 12** RF-Repeater, RC and 50 Ohm termination.

- The DC-block isolates the rail ground from the ground in the equipment shelter, and prevent all DC currents from flowing through the cables.

#### 4.6.3 1 x RF-Repeater and radiating cable with antenna inside the tunnel

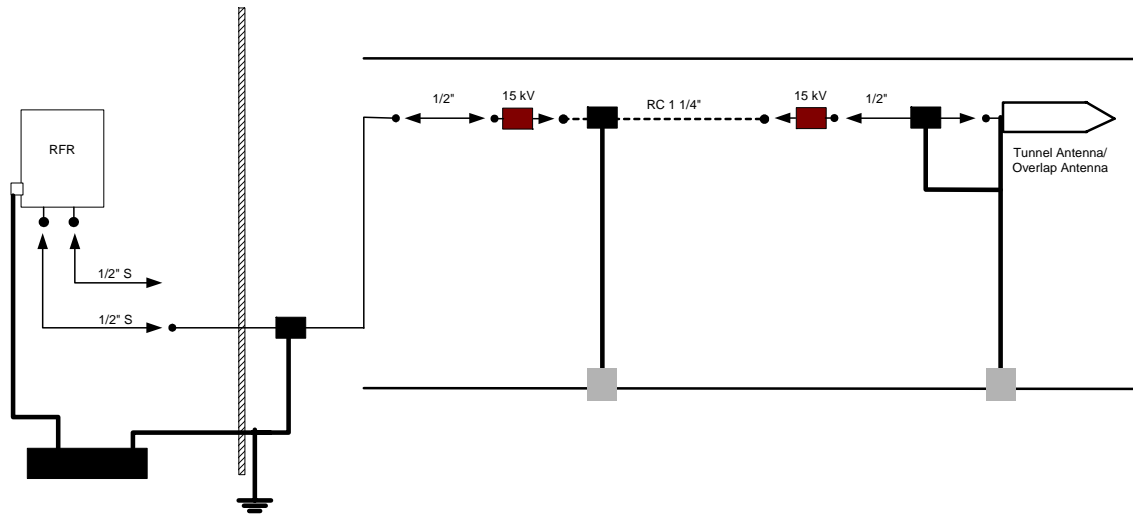
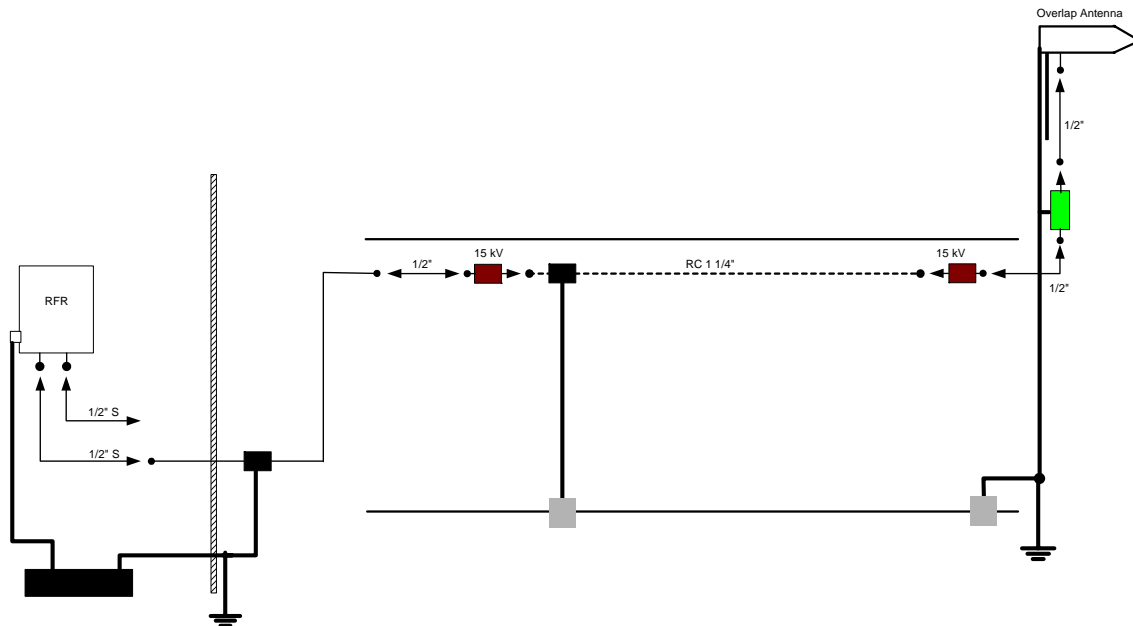

Figure 13 RF-Repeater, RC and overlap antenna inside the tunnel.

- The antenna is isolated from the tunnel rock to avoid return current from the train to flow trough the antenna.
- The DC-blocks isolates the rail ground from the ground in the equipment shelter, and prevent all DC currents from flowing through the cables.

#### 4.6.4 1 x RF-Repeater and radiating cable with antenna outside the tunnel



- The DC-blocks isolates the rail ground from the ground in the equipment shelter, and prevent all DC currents from flowing through the cables.
- A surge arrester is connected close to the antenna to protect the radiating cable and the repeater equipment against lightning. The surge arrester is connected to the ground cable coming from the antenna. Local ground is established. It is not necessary to isolate the antenna from the rock.

#### 4.6.5 2 x RF-Repeater and radiating cable

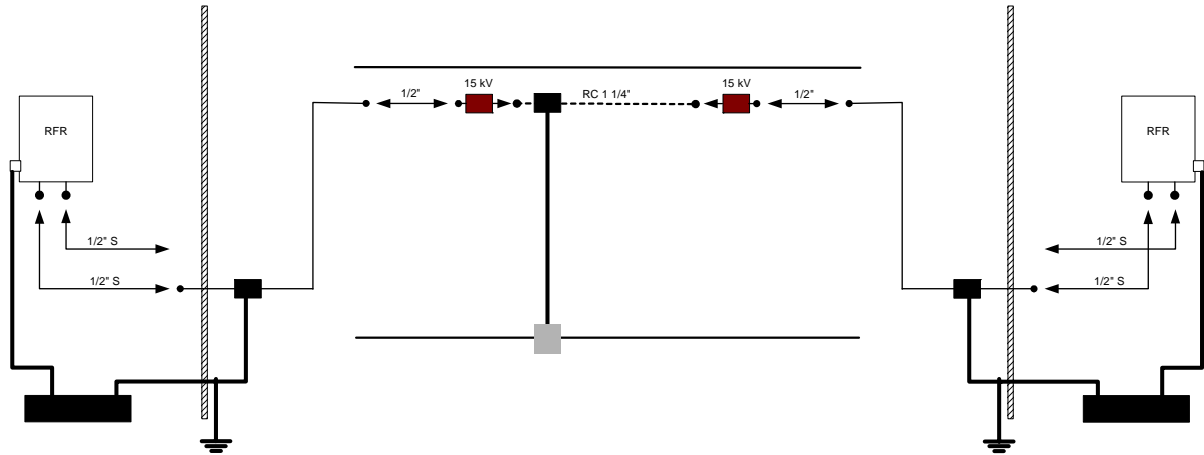

**Figure 14** 2 RF-Repeaters and RC

- The DC-blocks isolates the rail ground from the ground in the equipment shelter, and prevent all DC currents from flowing through the cables.

#### 4.6.6 Overlap/HO-antenna on the repeater side

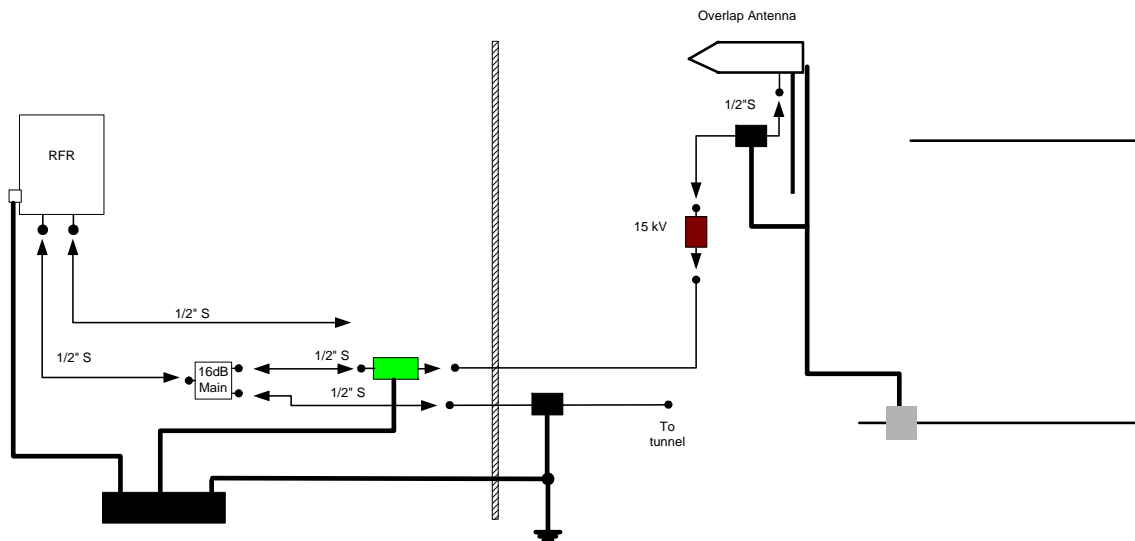
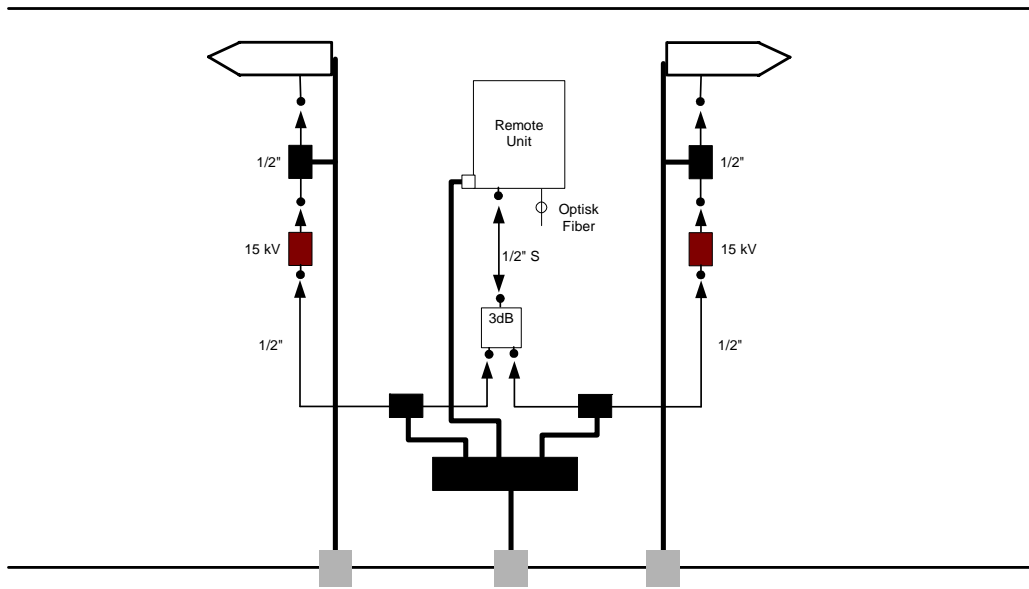

**Figure 15** RF-Repeater and Overlap Antenna on the repeater side.

- It is not necessary to isolate the antenna from the rock because it will be connected to the local ground
- The DC-blocks isolates the rail ground from the ground in the equipment shelter, and prevent all DC currents from flowing through the cables.

**If the antenna and feeders are not closer than 5m from the tracks, the same solution as for non-electrical lines shall be used.**

#### 4.6.7 1 x Remote Unit and antennas



**Figure 16** Remote Unit and Antennas

- The antennas are isolated from the tunnel rock to avoid return current from the train to flow trough the antenna.
- The DC-blocks prevent all DC currents from flowing through the cables.

#### 4.6.8 1 x Remote Unit and radiating cable

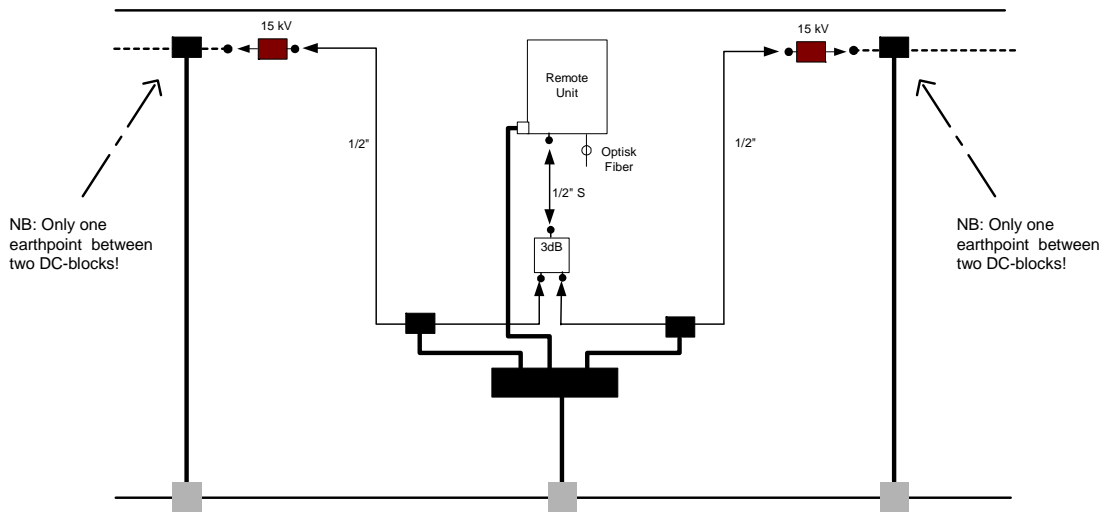

**Figure 17** Remote Unit and Radiating Cable.

- The DC-blocks isolates the rail ground from the ground in the equipment shelter, and prevent all DC currents from flowing through the cables.
- **Note:** There shall not be more than one earth kit on the radiating cable. That is only one earth kit between two DC-blocks.

<b>GSM-R Project</b>	<b>Network Design Grounding Principles</b>	Doc.no: GSM-00-A-20059 Date: 19.12.06 Rev.: 04D Page 21 of 22
----------------------	--	--

#### **4.6.9 Combinations of Remote Unit and RF-Repeater with radiating cable or 2 x Remote Unit with radiating cable**

##### 4.6.9.1 RF-Repeater and Remote Unit with radiating cable

For the RF-Repeater use the same principle as described for **2 x RF-Repeater and radiating cable.**

For the Remote Unit use the same principle as described for **1 x Remote Unit and radiating cable.**

##### 4.6.9.2 2 x Remote Unit with radiating cable

For each Remote Unit use the same principle as described for **1 x Remote Unit and radiating cable.**

## **5 Grounding requirements for different roll-out site types**

Netel has covered all aspects of main grounding for all various types of sites in the GSM-R project with respective grounding documents [3] - [29].

The main grounding is based upon a ring structure around the cabin/tower etc. All equipment (both 230V AC and 48V DC) will be connected to this ring on separate places. The ring will be extended with branches and terminated in the ground with x<sup>1</sup> nos. spears. The overall goal is to achieve a resistance of 40Ω. This is again dependant upon type of soil (swamp, rock, water or normal soil). All 48V DC telecom equipment will be grounded in the cabin on its own ground bar in one of the service racks, and from thereon be connected to the ring at a suitable place.

The grounding, for all different types of sites, will differ only when the site<sup>2</sup> is within the "slyngfelt" of electric railway lines. This is further described in chapter 4 Grounding principles tunnel system. The major differences are described below:

#### Non-electrical lines

- Antennas and radiating cables inside tunnels will not be grounded unless there is a risk of lightning.
- The antenna must be isolated from the rock to avoid different ground potential between the antenna and the repeater equipment if the antenna doesn't have local ground

#### Electrical lines

- Every antenna and radiating cable will be grounded.
- The antennas should always be isolated from the tunnel rock to avoid return current from the train to flow trough the antenna.
- The repeater equipment grounding shall be isolated form other ground potentials.
- The grounding in the shelter must not be connected directly to the rail ground.

<sup>1</sup> x – Number of spears depend upon the type of ground conditions, i.e. water, swamp, rock or normal soil.

<sup>2</sup> There are currently no BTS/MW sites planned within the "slyngfelt" of electrical lines.

<b>GSM-R Project</b>	<b>Network Design Grounding Principles</b>	Doc.no: GSM-00-A-20059
		Date: 19.12.06
		Rev.: 04D
		Page 22 of 22

## Reference List

#	Doc. no.	Document name	Comment
[1]		Jernbaneverket's tekniske regelverk, "Regler for prosjektering og bygging". JD 560 chapter 9,	
[2]		Jernbaneverket's tekniske regelverk, "Regler for prosjektering og bygging". JD 510 chapter 6, section 2.1	
[3]	GSM-00-X-10200	Detaljer jording	Jording – generelt
[4]	GSM-00-X-10201	Kategori 1 – under 30 Ohm. Jording i fjellgrunn	Jording – generelt
[5]	GSM-00-X-10202	Kategori 1 – under 30 Ohm. Jording i fjell og jord	Jording – generelt
[6]	GSM-00-X-10203	Kategori 1 – under 30 Ohm. Jording i jord	Jording – generelt
[7]	GSM-00-X-10204	Kategori 2 – under 60 Ohm. Jording i fjellgrunne	Jording – generelt
[8]	GSM-00-X-10205	Kategori 2 – under 60 Ohm. Jording i fjell og jord	Jording – generelt
[9]	GSM-00-X-10206	Kategori 2 – under 60 Ohm. Jording i jord	Jording – generelt
[10]	GSM-00-X-10207	Kategori 3 – under 100 Ohm. Jording i fjellgrunne	Jording – generelt
[11]	GSM-00-X-10208	Kategori 3 – under 100 Ohm. Jording i fjell og jord	Jording – generelt
[12]	GSM-00-X-10209	Kategori 3 – under 100 Ohm. Jording i jord	Jording – generelt
[12]	GSM-00-K-15020	Jording radiohytte Ringjord m/stråler i løsmasser	Jording – generelt
[13]	GSM-00-K-15021	Jording radiohytte Ringjord m/jordspyd i løsmasser	Jording – generelt
[14]	GSM-00-K-15022	Jording radiohytte Ringjord m/kråkefot i myr	Jording – generelt
[15]	GSM-00-K-15023	Jording radiohytte Ringjord m/jordspyd i fjell	Jording – generelt
[16]	GSM-00-K-15024	Jording radiohytte Jordingsanlegg m/jordspyd i fjell	Jording – generelt
[17]	GSM-00-K-15025	Jording radiohytte i Ringjord m/plate i vann	Jording – generelt
[18]	GSM-00-K-15026	Jording radiohytte Ringjord m/jordspyd i fjell 2m	Jording – generelt
[19]	GSM-00-K-15027	Feste av jordledning Klammer på fjell	Jording – generelt
[20]	GSM-00-K-15029	Jordingsdetalj krav til bøyeradius	Jording – generelt
[21]	GSM-00-K-15030	Jording Jordspyd i fjell	Jording – generelt
[22]	GSM-00-K-15031	Feste av jordeledning Klammer for PN 50mm <sup>2</sup>	Jording – generelt
[23]	GSM-00-K-15034	Jording repeater ramme Jordspyd i tunnel	Jording – generelt
[24]	GSM-00-K-15035	Jordspyd i fjell 2m hull	Jording – generelt
[25]	GSM-00-K-15082	Jording i grus mast i grus	Jording – generelt
[26]	GSM-00-K-15075	Jording impedans til skinner kabelføring feste til skinne	Jording – spesielt elektrifisert bane
[27]	GSM-00-K-15109	Prinsipper for jording av RC, antenner og repeater skisse 1-3	Jording – spesielt elektrifisert bane
[28]	GSM-00-K-15113	Prinsipper for jording av RC, antenner og repeater skisse 4-6	Jording – spesielt elektrifisert bane
[29]	GSM-00-K-15114	Prinsipper for jording av RC, antenner og repeater skisse 7-9	Jording – spesielt elektrifisert bane